

V2.00.001
11-15-2022

Statement: LAUNCH owns the complete intellectual property rights for the software used by this product. For any reverse engineering or cracking actions against the software, LAUNCH will block the use of this product and reserve the right to pursue their legal liabilities.

Trademarks

LAUNCH is a registered trademark of LAUNCH TECH CO., LTD. in China and other countries. All other marks are trademarks or registered trademarks of their respective holders.

Copyright Information

Copyright © 2022 by LAUNCH TECH CO., LTD. (also called LAUNCH for short). All rights reserved. No part of this publication may be reproduced, stored in a retrieval system, or transmitted in any form or by any means, electronic, mechanical, photocopying and recording or otherwise, without the prior written permission.

Disclaimer of Warranties and Limitation of Liabilities

- All information, illustrations, and specifications in this manual are based on the latest information available at the time of publication.
- The right is reserved to make changes at any time without notice. We shall not be liable for any direct, special, incidental, indirect damages or any economic consequential damages (including the loss of profits) due to the use of the document.
- To take full advantage of the unit, you should be familiar with the engine.
- LAUNCH shall not be liable for any damages or problems arising from the use of any options or any consumable products other than those designated as Original LAUNCH Products or LAUNCH Approved Products by LAUNCH.

Safety Precautions and Warnings

To prevent personal injury or damage to vehicles and/or the tool, please read this user's manual first carefully and observe the following safety precautions at a minimum whenever working on a vehicle:

- There are no user serviceable parts. Have the device serviced by a qualified repair person using only identical replacement parts. This will ensure that the safety of the device is maintained. Disassembling the device will void the warranty right.
- Caution: This tool contains an internal Lithium Polymer battery. The battery can burst or explode, releasing hazardous chemicals. To reduce the risk of fire or burns, do not disassemble, crush, pierce or dispose of the battery in fire or water.
- This product is not a toy. Do not allow children to play with or near this item.



- Do not expose the device to rain or wet conditions.
- Do not place the device on any unstable surface.
- Never leave the device unattended during charging process. The device must be placed on a non-flammable surface during charging.
- Handle the device with care. If the device is dropped, check for breakage and any other conditions that may affect its operation.
- Do not operate the tool in explosive atmospheres, such as in the presence of flammable liquids, gases, or heavy dust.
- Keep the tool dry, clean, free from oil, water or grease. Use a mild detergent on a clean cloth to clean the outside of the device when necessary.
- People with pacemakers should consult their physician(s) before use. Electromagnetic fields in close proximity to heart pacemaker could cause pacemaker interference or pacemaker failure.
- Always perform automotive testing in a safe environment.
- Do not attempt to operate or observe the tool while driving a vehicle. Operating or observing the tool will cause driver distraction and could cause a fatal accident.
- Wear safety eye protection that meets ANSI standards.
- Keep clothing, hair, hands, tools, test equipment, etc. away from all moving or hot engine parts.
- Operate the vehicle in a well-ventilated work area: Exhaust gases are poisonous.
- Put blocks in front of the drive wheels and never leave the vehicle unattended while running tests.
- Use extreme caution when working around the ignition coil, distributor cap, ignition wires and spark plugs. These components create hazardous voltages when the engine is running.
- Put the transmission in P (for A/T) or N (for M/T) and make sure the parking brake is engaged.
- Keep a fire extinguisher suitable for gasoline/chemical/ electrical fires nearby.
- Don't connect or disconnect any test equipment while the ignition is on or the engine is running.



FCC Statement

Any changes or modifications not expressly approved by the party responsible for compliance could void the user's authority to operate the equipment.

This device complies with Part 15 of the FCC Rules. Operation is subject to the following two conditions:

- (1) This device may not cause harmful interference, and
- (2) This device must accept any interference received, including interference that may cause undesired operation.

Note: This equipment has been tested and found to comply with the limits for a Class B digital device, pursuant to part 15 of the FCC Rules. These limits are designed to provide reasonable protection against harmful interference in a residential installation. This equipment generates uses and can radiate radio frequency energy and, if not installed and used in accordance with the instructions, may cause harmful interference to radio communications. However, there is no guarantee that interference will not occur in a particular installation. If this equipment does cause harmful interference to radio or television reception, which can be determined by turning the equipment off and on, the user is encouraged to try to correct the interference by one or more of the following measures:

- Reorient or relocate the receiving antenna.
- Increase the separation between the equipment and receiver.
- Connect the equipment into an outlet on a circuit different from that to which the receiver is connected.
- Consult the dealer or an experienced radio/TV technician for help.



Table of Contents

1 Overview	1
1.1 Vehicle Coverage	1
1.2 On-Board Diagnostics (OBD) II	2
1.3 OBD II Definitions	2
1.4 Diagnostic Trouble Codes (DTCs).....	4
1.5 Location of the Data Link Connector (DLC).....	6
1.6 OBD II Monitors	7
1.6.1 Continuous Monitors.....	8
1.6.2 Non-Continuous Monitors.....	9
1.7 DTCs and MIL Status	13
2 Product Descriptions	15
2.1 Components & Controls	15
2.2 Technical Specifications	17
2.3 Accessories Checklist.....	17
3 Initial Use	18
3.1 Charging & Turning On/Off	18
3.1.1 Charging	18
3.1.2 Turning On/Off	18
3.2 Getting Started	18
3.3 Job Menu.....	19
3.4 Settings	21
3.4.1 Units of measurement	21
3.4.2 Automatic detection on connect.....	21
3.4.3 Firmware Fix.....	21
3.4.4 Display/Brightness.....	21
3.4.5 Sound	21
3.4.6 Network	21
3.4.7 Date/Time	21
3.4.8 Language.....	22
3.4.9 Workshop information.....	22
3.4.10 Recovery	22

3.4.11 Clean Up.....	22
4 Diagnose	23
4.1 Connection	23
4.2 Perform System Diagnostics	24
4.2.1 Smart Diagnosis (Auto-Detect).....	24
4.2.2 Manual Diagnosis	26
4.3 Perform OBD II Diagnosis	34
4.4 History	37
5 Reset.....	39
5.1 Oil Reset Service.....	39
5.2 Electronic Parking Brake Reset.....	40
5.3 Steering Angle Calibration.....	40
5.4 ABS Bleeding.....	40
5.5 Gear Learning.....	40
5.6 IMMO Service.....	41
5.7 Injector Coding	41
5.8 Battery Maintenance System Reset	41
5.9 Diesel Particulate Filter (DPF) Regeneration	42
5.10 Electronic Throttle Position Reset	42
5.11 Gearbox Matching	42
5.12 AFS (Adaptive Front-lighting System) Reset	42
5.13 Sunroof Initialization	42
5.14 Suspension Calibration	42
5.15 EGR Adaption.....	43
5.16 Seats Calibration	43
5.17 Tyre Reset	43
5.18 Coolant Bleed	43
5.19 AdBlue Reset (Diesel Engine Exhaust Gas Filter).....	43
5.20 NOx Sensor Reset.....	43
5.21 AC System Initialization.....	43
5.22 High Voltage Battery Detection.....	44
5.23 Windows Calibration.....	44

5.24 Language Change	44
5.25 A/F Reset.....	44
5.26 Transport Mode	44
5.27 Stop/Start Reset	44
5.28 Intelligent Cruise Control System Reset.....	44
5.29 Engine Power Balance Monitoring	44
5.30 Gas Particulate Filter (GPF) Regeneration.....	44
5.31 Motor Angle Calibration	45
6 Data.....	46
6.1 Diagnostic Report.....	46
6.2 Diagnostic Record	46
6.3 DTC Library	47
6.4 DLC(Data Link Connector) Location.....	47
6.5 Feedback.....	47
6.6 Firmware Fix.....	48
6.7 FAQ	48
6.8 Image.....	48
6.9 I/M.....	48
7 Upgrade.....	49
8 Mail.....	50
9 FAQ	51
Warranty	53

1 Overview

1.1 Vehicle Coverage

This diagnostic tool is specially designed to work with all OBD II compliant vehicles, including Controller Area Network (CAN). It is required by EPA that all 1996 and newer vehicles (cars and light trucks) sold in the United States must be OBD II compliant and this includes all American, Asian and European vehicles.

A small number of 1994 and 1995 model year gasoline vehicles are OBD II compliant. To verify if a 1994 or 1995 vehicle is OBD II compliant, check the following:

1. **Vehicle Emissions Control Information (VECI) Label.** It is located under the hood or by the radiator of most vehicles. If the vehicle is OBD II compliant, the label will designate **OBD II Certified**.

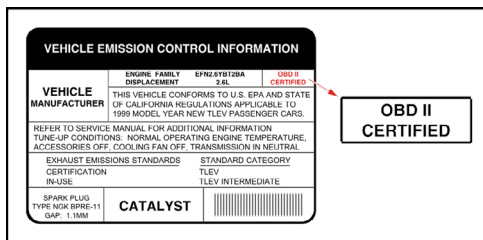

2. Government regulations mandate that all OBD II compliant vehicles **must** have a "common" 16-pin **Data Link Connector (DLC)**.

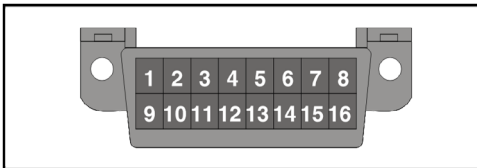

 Note: Some 1994 and 1995 vehicles have 16-pin connectors but are not OBD II compliant. Only those vehicles with a Vehicle Emissions Control Label stating **OBD II Certified** are OBD II compliant.

1.2 On-Board Diagnostics (OBD) II

 Note: With the exception of some 1994 and 1995 vehicles, most vehicles from 1982 to 1995 are equipped with some type of first generation On-Board Diagnostics.

OBD II is an early warning system designed to monitor engine, transmission, and emissions control components by performing specific diagnostic test.

When a fault condition is detected, the system captures important data and activates the “Check Engine” light.

If the light comes on, the vehicle might have a condition that wastes fuel, shortens engine life, or causes excessive air pollution. If the problem that caused the light to come on is addressed, for instance a loose gap is tightened, the light will go out.

If the light comes on and stays on, a minor engine fault condition is occurring and should be addressed as soon as possible.

If the light is blinking, a severe engine fault condition is occurring and should be addressed immediately.

The diagnostic tool connects to the vehicle’s computer system and captures information that can help identify the fault condition.

1.3 OBD II Definitions

The following terms and their definitions are related to OBD II systems. Read and reference this list as needed to aid in the understanding of OBD II systems.

EOBD - European On-Board Diagnostics. Essentially the same as OBD II, with the same Data Link Connector and Communication Protocols.

Communication Protocols - Allows different systems and sensors in a vehicle to communicate. There are currently five protocols:

CAN Bus

J1850 VPW

ISO 9141-2

J1850 PWM

ISO 14230 KWP

Powertrain Control Module (PCM) -- The PCM is the OBD II accepted term for the vehicle’s “on-board computer.” In addition to controlling the engine

management and emissions systems, the PCM also participates in controlling the powertrain (transmission) operation. Most PCMs also have the ability to communicate with other computers on the vehicle (ABS, ride control, body, etc.).

DLC -- Data Link Connector. The 16-cavity connector on the vehicle that allows communication between the computer system and the diagnostic tool.

MIL -- Malfunction Indicator Lamp. The vehicle's "Check Engine" warning light that activates when a DTC is stored.

DTC -- Diagnostic Trouble Code. A code stored in the computer system's memory, which helps to identify the fault condition that is causing the MIL to activate.

Freeze Frame Data -- Operating conditions that are stored when a DTC is stored.

PID -- Parameter Identification Data. Data returned by the vehicle's control modules to the diagnostic tool.

Monitors -- Monitors are "diagnostic routines" programmed into the PCM. The PCM utilizes these programs to run diagnostic tests, and to monitor operation of the vehicle's emissions-related components or systems to ensure they are operating correctly and within the vehicle's manufacturer specifications. Currently, up to fifteen Monitors are used in OBD II systems. Additional Monitors will be added as the OBD II system is further developed.



Note: Not all vehicles support all fifteen Monitors.

Enabling Criteria -- Also termed Enabling Conditions. They are the vehicle-specific events or conditions that must occur within the engine before the various monitors will set, or run. Some monitors require the vehicle to follow a prescribed "drive cycle" routine as part of the enabling criteria. Drive cycles vary among vehicles and for each monitor in any particular vehicle. Please refer to the vehicle's factory service manual for specific enabling procedures.

Trip - A Trip for a particular Monitor requires that the vehicle is being driven in such a way that all the required "Enabling Criteria" for the Monitor to run and complete its diagnostic testing are met. The "Trip Drive Cycle" for a particular Monitor begins when the ignition key is turned "On." It is successfully completed when all the "Enabling Criteria" for the Monitor to run and complete its diagnostic testing are met by the time the ignition key is turned "Off." Since each of the fifteen monitors is designed to run diagnostics and testing on a

different part of the engine or emissions system, the “Trip Drive Cycle” needed for each individual Monitor to run and complete varies.

Drive Cycle -- A specific mode of vehicle operation that provides conditions required to set all the readiness monitors applicable to the vehicle to the “ready” condition. The purpose of completing an OBD II drive cycle is to force the vehicle to run its onboard diagnostics. Some form of a drive cycle needs to be performed after DTCs have been erased from the PCM’s memory or after the battery has been disconnected. Running through a vehicle’s complete drive cycle will “set” the readiness monitors so that future faults can be detected. Drive cycles vary depending on the vehicle and the monitor that needs to be reset. For vehicle specific drive cycle, consult the service manual.

 Note: Do not confuse a “Trip” Drive Cycle with an OBD II Drive Cycle. A “Trip” Drive Cycle provides the “Enabling Criteria” for one specific Monitor to run and complete its diagnostic testing. An OBD II Drive Cycle must meet the “Enabling Criteria” for all Monitors on a particular vehicle to run and complete their diagnostic testing.

Warm-up Cycle - Vehicle operation after an engine off period where engine temperature rises at least 40°F (22°C) from its temperature before starting, and reaches at least 160°F (70°C). The PCM uses warm-up cycles as a counter to automatically erase a specific code and related data from its memory. When no faults related to the original problem are detected within a specified number of warm-up cycles, the code is erased automatically.

Fuel Trim (FT) - Feedback adjustments to the base fuel schedule. Short-term fuel trim refers to dynamic or instantaneous adjustments. Long-term fuel trim refers to much more gradual adjustments to the fuel calibration schedule than short-term trim adjustments. These long-term adjustments compensate for vehicle differences and gradual changes that occur over time.

1.4 Diagnostic Trouble Codes (DTCs)

OBD II Diagnostic Trouble Codes are codes that are stored by the on-board computer diagnostic system in response to a problem found in the vehicle. These codes identify a particular problem area and are intended to provide you with a guide as to where a fault might be occurring within a vehicle. **DO NOT** replace parts based only on DTCs without first consulting the vehicle’s service manual for proper testing procedures for that particular system, circuit or component.

OBD II Diagnostic Trouble Codes consist of a five-digit alphanumeric code.

- The 1st character is a **letter** (B, C, P or U). It identifies the **main system** where the fault occurred (Body, Chassis, Powertrain, or Network).
- The 2nd character is a **numeric digit** (0 thru 3). It identifies the **type** of code (Generic or Manufacturer-Specific).

 Note: Generic DTCs are codes that are used by all vehicle manufacturers.

The standards for generic DTCs, as well as their definitions, are set by the Society of Automotive Engineers (SAE).

Manufacturer-Specific DTCs are codes that are controlled by the vehicle manufacturers. The Federal Government does not require vehicle manufacturers to go beyond the standardized generic DTCs in order to comply with the new OBD II emissions standards. However, manufacturers are free to expand beyond the standardized codes to make their systems easier to diagnose.

-
- The 3rd character is a letter or a **numeric digit** (0 thru 9, A thru F). It identifies the specific system or sub-system where the problem is located.
 - The 4th and 5th characters are **letters** or **numeric digits** (0 thru 9, A thru F). They identify the section of the system that is malfunctioning.

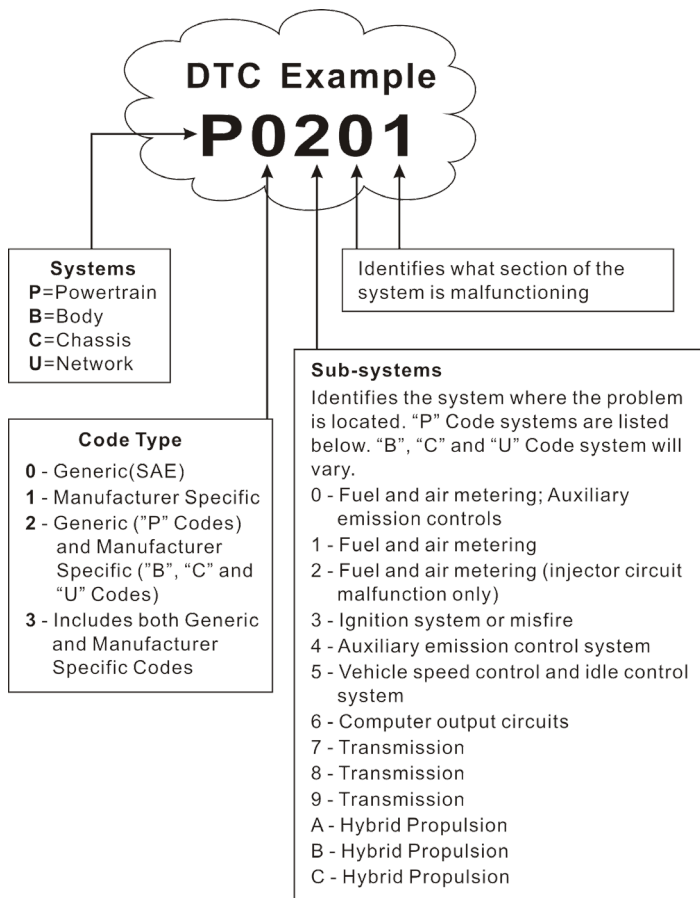

P0201 - Injector circuit malfunction, Cylinder 1

1.5 Location of the Data Link Connector (DLC)

The DLC (Data Link Connector or Diagnostic Link Connector) is typically a 16-pin connector where diagnostic code readers interface with the vehicle's on-board computer. It is usually located 12 inches from the center of the

instrument panel, under or around the driver's side for most vehicles. For some vehicles with special designs, the DLC location may vary.

Refer to the following figure for location.

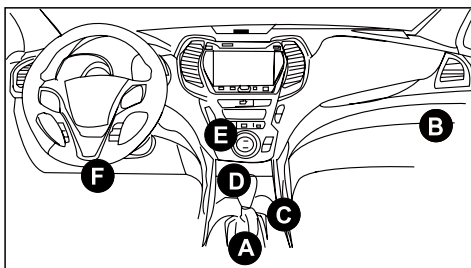

A	Opel, Volkswagen, Audi
B	Honda
C	Volkswagen
D	Opel, Volkswagen, Citroen
E	Changan
F	Hyundai, Daewoo, Kia, Honda, Toyota, Nissan, Mitsubishi, Renault, Opel, BMW, Mercedes-Benz, Mazda, Volkswagen, Audi, GM, Chrysler, Peugeot, Regal, Beijing Jeep, Citroen and other most popular models

If the DLC cannot be found, refer to the vehicle's service manual for the location.

1.6 OBD II Monitors

An important part of a vehicle's OBD II system is the Readiness Monitors, which are indicators used to find out if all of the emissions components have been evaluated by the OBD II system. They are running periodic tests on specific systems and components to ensure that they are performing within allowable limits.

Monitor operation is either "Continuous" or "Non-Continuous," depending on the specific monitor.

1.6.1 Continuous Monitors

Some of the vehicle components or systems are continuously tested by the vehicle's OBD II system, while others are tested only under specific vehicle operating conditions. The continuously monitored components listed below are always ready:

1. Misfire Monitor

This Monitor continuously checks for engine misfires. A misfire occurs when the air-fuel mixture in the cylinder does not ignite. The misfire Monitor uses changes in crankshaft speed to sense an engine misfire. When a cylinder misfires, it no longer contributes to the speed of the engine, and engine speed decreases each time the affected cylinder(s) misfire. The misfire Monitor is designed to sense engine speed fluctuations and determine from which cylinder(s) the misfire is coming, as well as how bad the misfire is.

There are three types of engine misfires, Types 1, 2, and 3.

- Type 1 and Type 3 misfires are two-trip monitor faults. If a fault is sensed on the first trip, the computer temporarily saves the fault in its memory as a Pending Code. The MIL is not commanded on at this time. If the fault is found again on the second trip, under similar conditions of engine speed, load and temperature, the computer commands the MIL "On," and the code is saved in its long term memory.
- Type 2 misfires are the most severe type of misfire. When a Type 2 misfire is sensed on the first trip, the computer commands the MIL to light when the misfire is sensed. If the computer determines that a Type 2 misfire is severe, and may cause catalytic converter damage, it commands the MIL to "flash" once per second as soon as the misfire is sensed. When the misfire is no longer present, the MIL reverts to steady "On" condition.

The Misfire Monitor is supported by both "spark ignition" vehicles and "compression ignition" vehicles.

2. Fuel System Monitor

This Monitor uses a Fuel System Correction program, called Fuel Trim, inside the on-board computer. Fuel Trim is a set of positive and negative values that represent adding or subtracting fuel from the engine. This program is used to correct for a lean (too much air/not enough fuel) or rich (too much fuel/not enough air) air-fuel mixture. The program is designed to add or subtract fuel, as needed, up to a certain percent. If the correction needed is too large and exceeds the time and percent allowed by the program, a fault is indicated by the computer.

The Fuel System Monitor is supported by both “spark ignition” vehicles and “compression ignition” vehicles. The Fuel System Monitor may be a “One-Trip” or “Two-Trip” Monitor, depending on the severity of the problem.

3. Comprehensive Components Monitor (CCM)

This Monitor continuously checks all inputs and outputs from sensors, actuators, switches and other devices that provide a signal to the computer. The Monitor checks for shorts, opens, out of range value, functionality and “rationality*.”

The CCM is supported by both “spark ignition” vehicles and “compression ignition” vehicles. The CCM may be either a “One-Trip” or a “Two-Trip” Monitor, depending on the component.

1.6.2 Non-Continuous Monitors

“Non-continuous” Monitors perform and complete their testing once per trip. The “non-continuous” Monitors are:

1. O₂ Sensor Monitor

The Oxygen Sensor monitors how much oxygen is in the vehicle’s exhaust. It generates a varying voltage of up to one volt, based on how much oxygen is in the exhaust gas, and sends the signal to the computer. The computer uses this signal to make corrections to the air/fuel mixture. If the exhaust gas has a large amount of oxygen (a lean air/fuel mixture), the oxygen sensor generates a “low” voltage signal. If the exhaust gas has very little oxygen (a rich mixture condition), the oxygen sensor generates a “high” voltage signal. A 450mV signal indicates the most efficient, and least polluting, air/fuel ratio of 14.7 parts of air to one part of fuel.

The oxygen sensor must reach a temperature of at least 600-650°F, and the engine must reach normal operating temperature, for the computer to enter into closed-loop operation.

The oxygen sensor only functions when the computer is in closed-loop. A properly operating oxygen sensor reacts quickly to any change in oxygen content in the exhaust stream. A faulty oxygen sensor reacts slowly, or its voltage signal is weak or missing.

The Oxygen Sensor Monitor is supported by “spark ignition” vehicles only. The Oxygen Sensor Monitor is a “Two-Trip” monitor. If a fault is found on the first trip, the computer temporarily saves the fault in its memory as a Pending Code. The computer does not command the MIL on at this time. If the fault is sensed again on the second trip, the computer commands the MIL “On,” and saves the code in its long-term memory.

2. O₂ Sensor Heater Monitor

The Oxygen Sensor Heater Monitor tests the operation of the oxygen sensor's heater. There are two modes of operation on a computer-controlled vehicle: "open-loop" and "closed-loop." The vehicle operates in open-loop when the engine is cold, before it reaches normal operating temperature. The vehicle also goes to open-loop mode at other times, such as heavy load and full throttle conditions. When the vehicle is running in open-loop, the oxygen sensor signal is ignored by the computer for air/fuel mixture corrections. Engine efficiency during open-loop operation is very low, and results in the production of more vehicle emissions.

Closed-loop operation is the best condition for both vehicle emissions and vehicle operation. When the vehicle is operating in closed-loop, the computer uses the oxygen sensor signal for air/fuel mixture corrections.

In order for the computer to enter closed-loop operation, the oxygen sensor must reach a temperature of at least 600°F. The oxygen sensor heater helps the oxygen sensor reach and maintain its minimum operating temperature (600°F) more quickly, to bring the vehicle into closed-loop operation as soon as possible.

The Oxygen Sensor Heater Monitor is supported by "spark ignition" vehicles only. The Oxygen Sensor Heater Monitor is a "Two-Trip" Monitor. If a fault is found on the first trip, the computer temporarily saves the fault in its memory as a Pending Code. The computer does not command the MIL on at this time. If the fault is sensed again on the second trip, the computer commands the MIL "On," and saves the code in its long-term memory.

3. Catalyst Monitor

The catalytic converter is a device that is installed downstream of the exhaust manifold. It helps to oxidize (burn) the unburned fuel (hydrocarbons) and partially burned fuel (carbon monoxide) left over from the combustion process. To accomplish this, heat and catalyst materials inside the converter react with the exhaust gases to burn the remaining fuel. Some materials inside the catalytic converter also have the ability to store oxygen, and release it as needed to oxidize hydrocarbons and carbon monoxide. In the process, it reduces vehicle emissions by converting the polluting gases into carbon dioxide and water.

The computer checks the efficiency of the catalytic converter by monitoring the oxygen sensors used by the system. One sensor is located before (upstream of) the converter; the other is located after (downstream of) the converter. If the catalytic converter loses its ability to store oxygen, the downstream sensor

signal voltage becomes almost the same as the upstream sensor signal. In this case, the monitor fails the test.

The Catalyst Monitor is supported by “spark ignition” vehicles only. The Catalyst Monitor is a “Two-Trip” Monitor. If a fault is found on the first trip, the computer temporarily saves the fault in its memory as a Pending Code. The computer does not command the MIL on at this time. If the fault is sensed again on the second trip, the computer commands the MIL “On” and saves the code in its long-term memory.

4. Heated Catalyst Monitor

Operation of the “heated” catalytic converter is similar to the catalytic converter. The main difference is that a heater is added to bring the catalytic converter to its operating temperature more quickly. This helps reduce emissions by reducing the converter’s down time when the engine is cold. The Heated Catalyst Monitor performs the same diagnostic tests as the catalyst Monitor, and also tests the catalytic converter’s heater for proper operation.

The Heated Catalyst Monitor is supported by “spark ignition” vehicles only. This Monitor is also a “Two-Trip” Monitor.

5. EGR (Exhaust Gas Recirculation) System Monitor

The Exhaust Gas Recirculation (EGR) system helps reduce the formation of Oxides of Nitrogen during combustion. Temperatures above 2500°F cause nitrogen and oxygen to combine and form Oxides of Nitrogen in the combustion chamber. To reduce the formation of Oxides of Nitrogen, combustion temperatures must be kept below 2500°F. The EGR system recirculates small amounts of exhaust gas back into the intake manifold, where it is mixed with the incoming air/fuel mixture. This reduces combustion temperatures by up to 500°F. The computer determines when, for how long, and how much exhaust gas is recirculated back to the intake manifold. The EGR Monitor performs EGR system function tests at preset times during vehicle operation.

The EGR Monitor is supported by both “spark ignition” vehicles and “compression ignition” vehicles. The EGR Monitor is a “Two-Trip” Monitor. If a fault is found on the first trip, the computer temporarily saves the fault in its memory as a Pending Code. The computer does not command the MIL on at this time. If the fault is sensed again on the second trip, the computer commands the MIL “On,” and saves the code in its long-term memory.

6. Evaporative System Monitor

OBD II vehicles are equipped with a fuel Evaporative system (EVAP) that helps prevent fuel vapors from evaporating into the air. The EVAP system carries fumes from the fuel tank to the engine where they are burned during combustion. The EVAP system may consist of a charcoal canister, fuel tank cap, purge solenoid, vent solenoid, flow monitor, leak detector and connecting tubes, lines and hoses.

Fumes are carried from the fuel tank to the charcoal canister by hoses or tubes. The fumes are stored in the charcoal canister. The computer controls the flow of fuel vapors from the charcoal canister to the engine via a purge solenoid. The computer energizes or deenergizes the purge solenoid (depending on solenoid design). The purge solenoid opens a valve to allow engine vacuum to draw the fuel vapors from the canister into the engine where the vapors are burned. The EVAP Monitor checks for proper fuel vapor flow to the engine, and pressurizes the system to test for leaks. The computer runs this Monitor once per trip.

The EVAP Monitor is supported by “spark ignition” vehicles only. The EVAP Monitor is a “Two-Trip” Monitor. If a fault is found on the first trip, the computer temporarily saves the fault in its memory as a Pending Code. The computer does not command the MIL on at this time. If the fault is sensed again on the second trip, the PCM commands the MIL “On,” and saves the code in its long-term memory.

7. Secondary Air System Monitor

When a cold engine is first started, it runs in open-loop mode. During open-loop operation, the engine usually runs rich. A vehicle running rich wastes fuel and creates increased emissions, such as carbon monoxide and some hydrocarbons. A Secondary Air System injects air into the exhaust stream to aid catalytic converter operation:

- It supplies the catalytic converter with the oxygen it needs to oxidize the carbon monoxide and hydrocarbons left over from the combustion process during engine warmup.
- The extra oxygen injected into the exhaust stream also helps the catalytic converter reach operating temperature more quickly during warm-up periods. The catalytic converter must heat to operating temperature to work properly.

The Secondary Air System Monitor checks for component integrity and system operation, and tests for faults in the system. The computer runs this Monitor once per trip.

The Secondary Air System Monitor is a “Two-Trip” monitor. If a fault is found

on the first trip, the computer temporarily saves this fault in its memory as a Pending Code. The computer does not command the MIL on at this time. If the fault is sensed again on the second trip, the computer commands the MIL “On,” and saves the code in its long-term memory.

1.7 DTCs and MIL Status

When the vehicle’s on-board computer detects a failure in an emissions-related component or system, the computer’s internal diagnostic program assigns a diagnostic trouble code (DTC) that points to the system (and subsystem) where the fault was found. The diagnostic program saves the code in the computer’s memory. It records a “Freeze Frame” of conditions present when the fault was found, and lights the Malfunction Indicator Lamp (MIL). Some faults require detection for two trips in a row before the MIL is turned on.



Note: The “Malfunction Indicator Lamp” (MIL) is the accepted term used to describe the lamp on the dashboard that lights to warn the driver that an emissions-related fault has been found. Some manufacturers may still call this lamp a “Check Engine” or “Service Engine Soon” light.

There are two types of DTCs used for emissions-related faults: Type “A” and Type “B.” Type “A” codes are “One-Trip” codes; Type “B” DTCs are usually Two-Trip DTCs.

When a **Type “A”** DTC is found on the First Trip, the following events take place:

- The computer commands the MIL “On” when the failure is first found.
- If the failure causes a severe misfire that may cause damage to the catalytic converter, the MIL “flashes” **once per second**. The MIL continues to flash as long as the condition exists. If the condition that caused the MIL to flash is no longer present, the MIL will light “steady” On.
- A DTC is saved in the computer’s memory for later retrieval.
- A “Freeze Frame” of the conditions present in the engine or emissions system when the MIL was ordered “On” is saved in the computer’s memory for later retrieval. This information shows fuel system status (closed loop or open loop), engine load, coolant temperature, fuel trim value, MAP vacuum, engine RPM and DTC priority.

When a **Type “B”** DTC is found on the First Trip, the following events take place:

- The computer sets a Pending DTC, but the MIL is not ordered “On.”

“Freeze Frame” data may or may not be saved at this time depending on manufacturer. The Pending DTC is saved in the computer’s memory for later retrieval.

- If the failure is found on the second consecutive trip, the MIL is ordered “On.” “Freeze Frame” data is saved in the computer’s memory.
- If the failure is not found on the second Trip, the Pending DTC is erased from the computer’s memory.

The MIL will stay lit for both Type “A” and Type “B” codes until one of the following conditions occurs:

- If the conditions that caused the MIL to light are no longer present for the next three trips in a row, the computer automatically turns the MIL “Off” if no other emissions-related faults are present. However, the DTCs remain in the computer’s memory as a history code for 40 warm-up cycles (80 warm-up cycles for fuel and misfire faults). The DTCs are automatically erased if the fault that caused them to be set is not detected again during that period.
- Misfire and fuel system faults require three trips with “similar conditions” before the MIL is turned “Off.” These are trips where the engine load, RPM and temperature are similar to the conditions present when the fault was first found.



Note: After the MIL has been turned off, DTCs and Freeze Frame data stay in the computer’s memory.

- Erasing the DTCs from the computer’s memory can also turn off the MIL. If a Diagnostic Tool is used to erase the codes, Freeze Frame data will also be erased.

2 Product Descriptions

2.1 Components & Controls

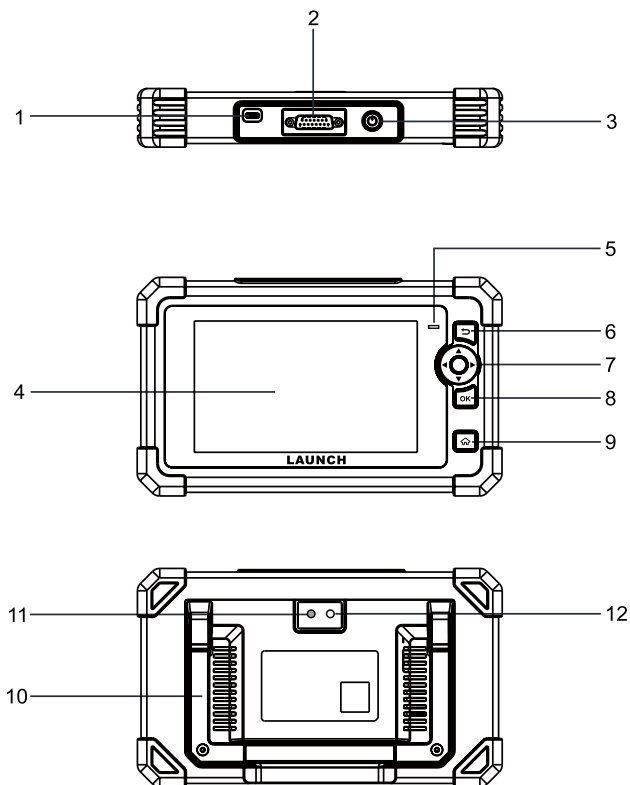

1. Charging Port

Connects the tool to PC to charge it.

2. DB15 Diagnostic Connector

Connects the tool to the vehicle's Data Link Connector (DLC).

3. Power Button

Turns on/off the tool.

4. Display Screen

Indicates test results.

5. Charging LED

Red means Charging; Green means Fully Charged.

6. Button

Returns to previous menu.

7. Select Buttons

Button

- When in MENU mode, scroll UP through the menu and submenu line by line.
- When in DATA VIEW mode, scroll through the screen data to the PREVIOUS page.

Button

When in MENU/DATA VIEW mode, scroll through the screen to the NEXT page.

Button

- When in MENU mode, scroll DOWN through the menu and submenu line by line.
- When in DATA VIEW mode, scroll through the screen data to the NEXT page.

Button

When in MENU/DATA VIEW mode, scroll through the screen to the PREVIOUS page.

8. OK Button

Confirms a selection (or action) from a MENU list.

9. HOME Button

Navigates to the Job Menu screen.

10. Adjustable Stand

Flip it out to any angle and work comfortable at your desk, or hang it on steering wheel.

11. Camera Flash

12. Rear Camera

2.2 Technical Specifications

- Screen: 7" touch screen
- RAM: 3GB
- ROM: 32GB
- OBDII input voltage range: 9~18V
- Touch & Keypad input
- Charging via:
 - DC 5V charging cable & power adaptor or
 - Diagnostic cable through connection to vehicle's DLC
- Dimension: 251.4mm x 150.6mm x 40.4mm
- Net weight: <600g
- Working temperature: -10 to 50°C (14 to 122 F°)
- Storage temperature: -20 to 70°C (-4 to 158 F°)

2.3 Accessories Checklist

The following accessory items are for reference purpose only. For detailed accessory items, please consult from the local agency.

1. Diagnostic tool x 1
2. OBD II diagnostic cable x 1
3. DC 5V charging cable x 1
4. Power adaptor x 2
5. Multilingual quick start guide x 1
6. User manual x 1

3 Initial Use

3.1 Charging & Turning On/Off

3.1.1 Charging

There are two charging methods available:

Via Charging Cable & Power Adaptor: Plug one end of the included charging cable into the DC-IN port of the tool, and the other end to the external DC power.

Via Diagnostic Cable: Insert one end of the diagnostic cable into the DB-15 connector of the tool, and the other end to the vehicle's DLC.

Once the charging LED illuminates solid green, it indicates that the battery is fully charged.

 Note: Attempting to charge the tool via OBD diagnostic port will consume vehicle's battery power. You are not recommended to charge the tool in this way except for OBD diagnosis operations.

3.1.2 Turning On/Off

Press  for about 3 seconds to turn it on.

Press  for about 8 seconds to turn it off.

3.2 Getting Started

If it is the first time you have used this tool, you need to make some system settings.

1. Power on the tool. The screen displays a welcome page. Tap **Welcome to use** to go to next step.
2. Choose the desired system language, and tap **Next step**.
3. Choose the desired time zone, and tap **Next step** to enter the WLAN setup screen.
4. Slide the switch to ON, the system starts searching for all available wireless LANs. Choose the desired WLAN access point / network,



- If the network you chose is open, you can connect directly.
- If the selected network is encrypted, you have to enter the right security key (network password).

 Note: If you choose **Ignore** in WLAN setup, it will go into the date setting page. If the tool has been properly connected to the Internet, the system will automatically obtain the correct network date and time and navigate to step 5.

5. After the network connection is done, tap **Next Step** to configure workshop information. Input the required information, and tap **Next Step** to go to next step.

 Note: After you configured it, the system will append it on the report every time a report is successfully generated.

6. Carefully read all terms and conditions of the user agreement, check the box before the **Agree to all the above terms**, and tap **OK** to finish the sign-up process and navigate to Job Menu.

3.3 Job Menu

The main menu screen includes the following function modules:

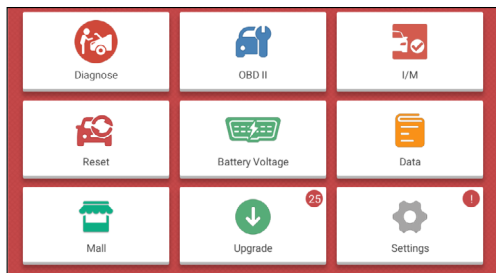

Diagnose	Configure it to operate as a professional diagnostic tool.
OBD II	This option presents a quick way to check for DTCs, isolate the cause of the illuminated Malfunction Indicator Lamp (MIL), check monitor status prior to emissions certification testing, verify repairs, and perform a number of other services that are emission-related.
I/M	This option checks whether or not the various emission-related systems on the vehicle are operating properly, and are ready for Inspection and Maintenance testing. It also can be used to confirm that the repair has been performed correctly, and/or to check for Monitor Run Status after the repair of a fault has been performed.
Reset	Perform commonly used repair & maintenance services.
Battery Voltage	Measure the current voltage of the vehicle's battery.
Data	Include Diagnostic report, Diagnostic record, Feedback and DTC library etc.
Mail	To subscribe extra vehicle diagnostic software or reset software that are not included within the tool.
Upgrade	Update vehicle diagnostic software and APK.  Note: This function requires a stable network connection.
Settings	Make some system settings, including Network setup, Email and Brightness etc.

3.4 Settings

3.4.1 Units of measurement

It is designed to set the measurement unit. Metric System and English System are available.

3.4.2 Automatic detection on connect

This option enables you to determine whether to start an automatic VIN detection once the tool is properly connected to the vehicle's DLC.

3.4.3 Firmware Fix

This option enables you to fix and repair the tire pressure firmware and the VCI firmware.

3.4.4 Display/Brightness

This item allows you to set the standby time and screen brightness.



Note: Reducing the brightness of the screen is helpful to conserve the power of the tool.

3.4.5 Sound

This option lets you adjust the volume and other sound settings.

3.4.6 Network



Note: Once WLAN is set as ON, the tool will consume more power. While it keeps unused, please set it off to save power. While WLAN keeps unused, please turn it off to conserve battery power.

The tool has built-in WLAN module that can be used to get online. Once you're online, you can register your tool and update diagnostic software & APK.

Slide the switch to ON, the system starts searching for all available wireless LANs. Choose the desired WLAN access point / network to connect.

3.4.7 Date/Time

This option allows you to set the system time and time zone.

3.4.8 Language

The tool supports multiple languages. You can use this option to change the system language to the target language.

3.4.9 Workshop information

This option allows you to configure the workshop information.

 Note: After you configured it, the system will append it on the report every time a report is successfully generated.

3.4.10 Recovery

Use this item to reset this tool to the default factory setting.

 Warning: Resetting may cause data loss. Before doing so, please be careful to perform this operation.

3.4.11 Clean Up

This option allows user to clear some cache files and free up some storage space. After clean up, the tool will reboot automatically.

3.4.12 About

This option displays the hardware configuration information of the tool and license agreement.

4 Diagnose

This function is specially designed to diagnose electronic control systems of single vehicle model.

4.1 Connection

- 1). Turn the ignition off.

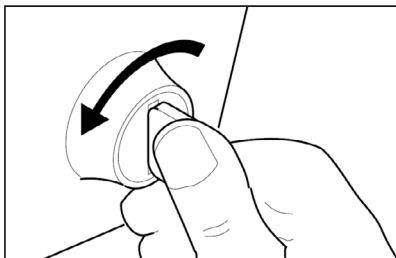

- 2). Locate the vehicle's 16-pin Data Link Connector (DLC). Refer to Chapter 2.4.
- 3). Plug one end of the diagnostic cable into the vehicle's DLC(Data Link Connector) port, and the other end to the DB-15 diagnostic connector of the tool, and then tighten the captive screws.

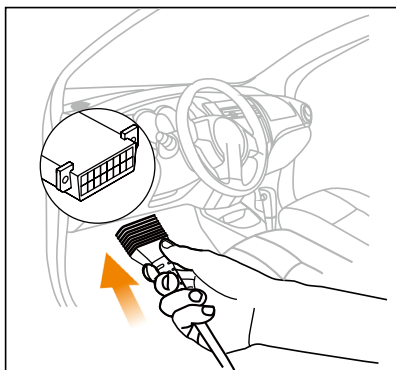

 Notes:

- A plastic DLC cover may be found for some vehicles and you need to remove it before plugging the diagnostic cable.
 - The cable connector is keyed and will only fit one way. If you have problems connecting the cable connector to the DLC, rotate the connector 180° and try again.
-

4). Turn the ignition on. Engine can be off or running.

 **Caution:** Don't connect or disconnect any test equipment with the ignition on or engine running.

5). Press the [POWER] button to turn it on and enter the Job Menu.

4.2 Perform System Diagnostics

This function is specially designed to diagnose electronic control systems of single vehicle model.

4.2.1 Smart Diagnosis (Auto-Detect)

This function allows you to quickly access the electronic control systems of the vehicle via decoding the VIN, without manual step-by-step menu selection.

After connection, turn the ignition key on and the system enters auto-detect mode ( Note: Please make sure the **Automatic detection on connect** in **Settings** is set as ON).

 Note: To detect more and accurate VINs, a stable network connection is highly recommended for this function.

 **Caution:** Don't connect or disconnect any test equipment with ignition on or engine running.

A. Once the system successfully obtains the VIN (Vehicle Identification Number) information of the currently identified vehicle, the following screen will appear.

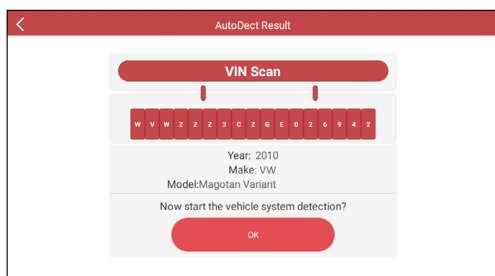

Tap “OK” to start diagnosing all available systems. After the diagnosis is completed, a diagnostic report will be automatically generated.

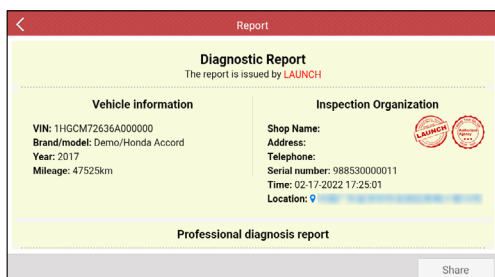

B. If the tool failed to access the VIN information, the following screen will appear:

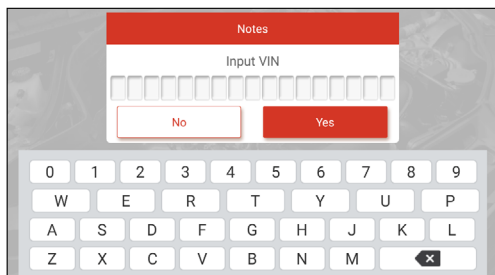

 Notes:

- The most recognizable location for this number is in the top left corner on the vehicle's dashboard. Other locations include the driver's door or post, and the firewall under the hood.
 - In general, vehicle identification numbers are standardized - all contain 17 characters. VIN characters may be capital letters A through Z and numbers 1 through 0; however, the letters I, O and Q are never used in order to avoid mistakes of misreading. No signs or spaces are allowed in the VIN.
-

Input the VIN, and tap **Yes**, the system will identify the vehicle model. After the vehicle VIN is successfully decoded, a diagnostic report will be automatically generated.

If the system can not decode the VIN of the test vehicle, it will enter manual diagnosis mode. For details on manual diagnosis, see Chapter 5.2.2.

4.2.2 Manual Diagnosis

If the tool can not obtain the VIN information, you can also perform vehicle diagnosis manually. In this mode, you need to execute the menu-driven command and then follow the on-screen instruction to proceed.

 Notes:

- Before diagnosing, please make sure the diagnostic program corresponding to certain vehicle model has been installed on your tool.
 - For vehicles manufactured by different vendors, it is possible that it has different diagnostic menus. For details, please follow the instructions on the screen to proceed.
-

Refer to the flowchart illustrated as below to diagnose a vehicle manually:

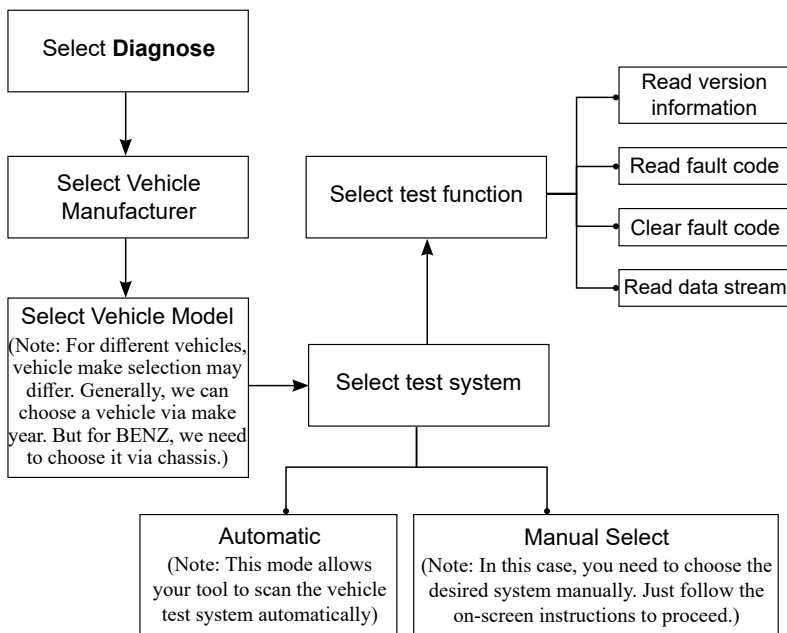

Take Demo as an example to demonstrate how to diagnose a vehicle.

- 1). Select diagnostic software version: Tap **OK** to enter the test item selection screen.

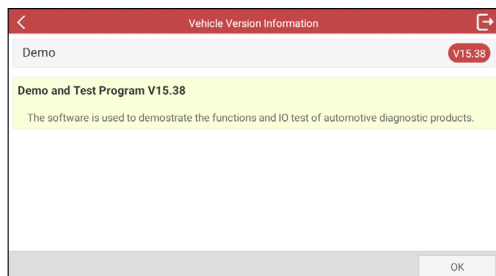

- 2). Select test vehicle (varies with different versions): Tap the target vehicle model (Take "HONDA" for example) to continue.

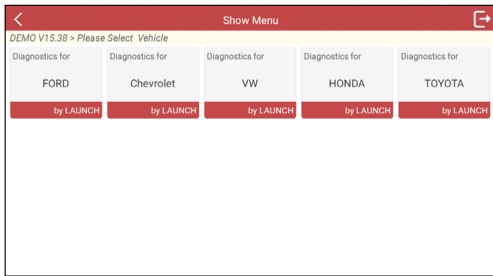

3). Turn on the ignition: Set the ignition switch to ON.

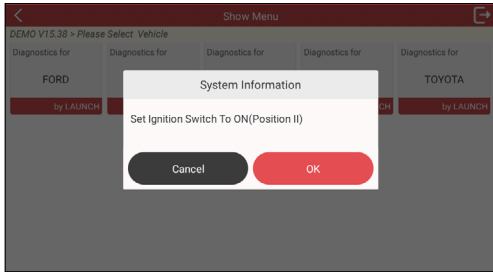

4). Confirm the vehicle information: Double check if the vehicle information is correct or not. If Yes, tap “Yes” to go to the next step.

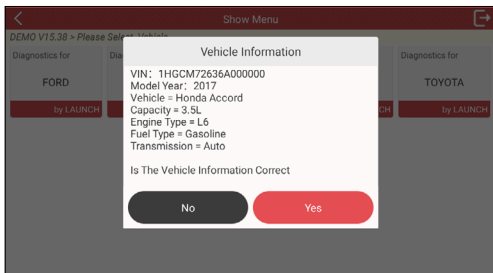

5). Select test item: Select the desired test item to proceed.

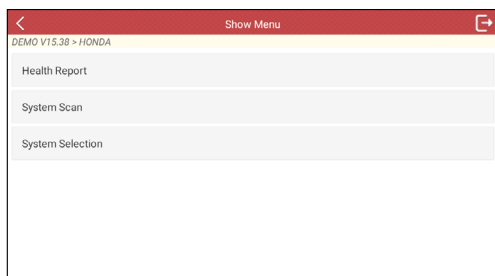

4.2.2.1 Health Report (Quick Test)

This function varies from vehicle to vehicle. It enables you to quickly access all the electronic control units of the vehicle and generate a detailed report about vehicle health.

Tap **Health Report** on the test item selection screen, the system starts scanning the ECUs. Once the scanning is complete, the following screen will appear:

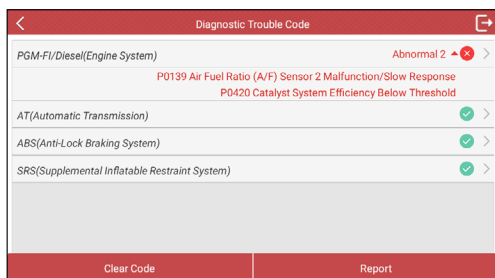

In above figure, the tested system with fault code appears in red and the system with OK displays in black (normally).

On-screen Buttons:

>: Tap to select other test functions. For detailed operations, refer to Chapter 4.2.2.2 **System Selection**.

Report: Tap to save the diagnostic result as a diagnostic report.

Clear DTC: Tap to clear the existing diagnostic trouble codes.

4.2.2.2 System Selection

This option allows you to quickly scan which systems are installed on the

vehicle.

4.2.2.3 System Selection

This option allows you manually select the test system and function step by step.

Tap **System Selection** on the test item selection screen, and tap the desired system (take **Engine System** for example) to enter the test function screen.



 Note: Different vehicle has different diagnostic menus.

A. Read Fault Code

This function displays the detailed information of DTC records retrieved from the vehicle's control system.

Tap **Read Fault Code** on the test function selection screen, the screen will display the diagnostic result.

 Note: Retrieving and using DTCs for troubleshooting vehicle operation is only one part of an overall diagnostic strategy. Never replace a part based only on the DTC definition. Each DTC has a set of testing procedures, instructions and flow charts that must be followed to confirm the location of the problem. This information can be found in the vehicle's service manual.

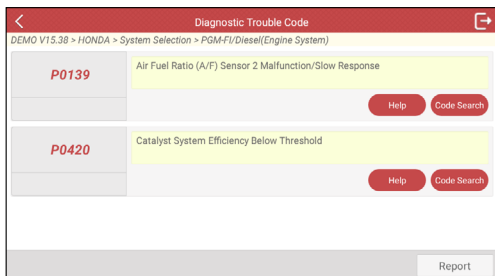

On-screen Buttons:

Help: Tap to view the help information.

Code Search: Tap it to search for more information about the current DTC online.

Report: To save the current data in text format. All diagnostic reports can be accessed from **Data -> Diagnostic Report**.

B. Clear Fault Code

After reading the retrieved codes from the vehicle and certain repairs have been carried out, you can use this function to erase the codes from the vehicle. Before performing this function, please be sure the vehicle's ignition key is in the ON position with the engine off.

Notes:

1. If you plan to take the vehicle to a Service Center for repair, **DO NOT** erase the codes from the vehicle's computer. If data is erased, valuable information that might help the technician troubleshoot the problem will also be erased.
2. Clearing DTCs does not fix the problem(s) that caused the code(s) to be set. If proper repairs to correct the problem that caused the code(s) to be set are not made, the code(s) will appear again and the check engine light will illuminate as soon as the problem that cause the DTC to set manifests itself.

C. Read Data Stream

This option retrieves and displays live data and parameters from the vehicle's ECU.

Tap **Read Data Stream** on the test function selection screen, the system will display data stream items.

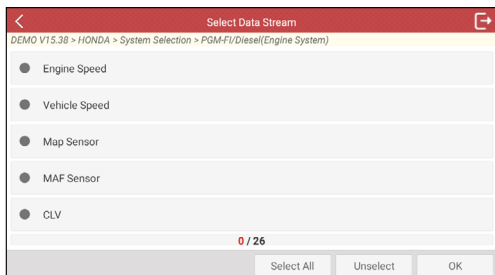

On-screen Buttons:

Select All: Tap it to select all items of the current page. To select certain data stream item, just check the box before the item name.

Unselect: Tap it to deselect all data stream items.

OK: Tap it to confirm and jump to the next step.

After selecting the desired items, tap **OK** to enter the data stream reading screen.

Data Stream Item	Value	Status
Engine Speed	974.00 rpm	Red
Vehicle Speed	0 mph	Red
Map Sensor	4.35 psi	Red
MAF Sensor	1.36 V	Red
CLV	29.82 %	Red
Baro Sensor	14.64 psi	Red

Notes:

1. If the value of the data stream item is out of the range of the standard (reference) value, the whole line will display in red. If it complies with the reference value, it displays in blue (normal mode).
2. The indicator 1/X shown on the bottom of the screen stands for the current page/total page number. Swipe the screen from the right/left to advance/return to the next/previous page.

There are 3 types of display modes available for data viewing, allowing you to view various types of parameters in the most suitable way.

- Value – this is the default mode which displays the parameters in texts and shows in list format.
- Graph – displays the parameters in waveform graphs.
- Combine – this option is mostly used in graph merge status for data comparison. In this case, different items are marked in different colors.

On-screen Buttons:

: Tap it to view the waveform graph of the current data stream item.

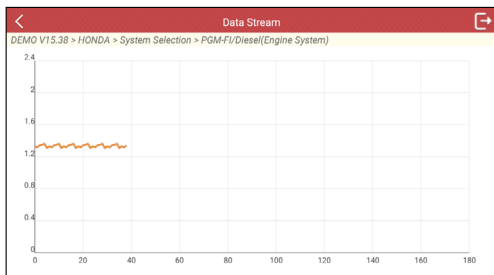

Combine: Tap it, a pull-down list of the data stream items appears on the screen. Select the necessary items and the screen will display the waveforms corresponding to these items immediately.

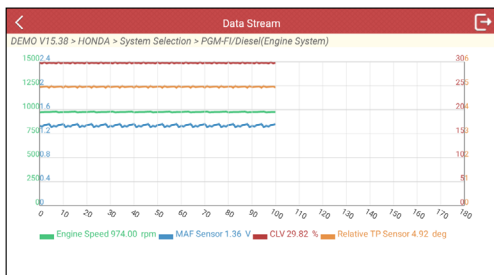

Report: Tap to save the current data as a diagnostic report. All diagnostic reports can be accessed from **Report -> Diagnostic Report**. The tool logs the Date of Report (the date and time at which the report was created) and assigns a unique Report #.

Record: Tap to record and save Live Data. Recorded Live Data can serve as valuable information to help you in troubleshooting and diagnosing vehicle problems. The saved file follows the naming rule: It begins with vehicle type,

and then the record starting time and ends with .x431 (To differentiate between files, please configure the accurate system time). All diagnostic records can be viewed by tapping **Report -> Diagnostic Record**.

Data Stream		
DEMO V15.38 > HONDA > System Selection > PGM-FI/Diesel(Engine System)		
CLV	29.82 %	
Baro Sensor	14.64 psi	
TP Sensor	15.67 %	
Relative TP Sensor	4.92 deg	
APP Sensor	0.00 %	
Throttle VLV	5.22 deg	
Recording	(1 / 3)	00:02
Combine		Report
Record		

4.3 Perform OBD II Diagnosis

This option presents a quick way to check for DTCs, isolate the cause of the illuminated Malfunction Indicator Lamp (MIL), check monitor status prior to emissions certification testing, verify repairs, and perform a number of other services that are emission-related.

After the tool is properly connected to the vehicle's DLC, tap "OBD II" in the Job Menu. The tool will automatically start a check of the vehicle's computer to determine which type of communication protocol it is using. When the tool identifies the computer's communication protocol, a communication link is established and then the screen will display the Monitor Status.

Scan Results	
EOBD V22.87 > Scan Results	
Item	Value
VIN	N/A
MIL Status	OFF
DTCs In This ECU	108
Readiness Completed	5
Readiness Not Completed	2
Readiness Not Connected	2
OK	Full protocol scanning

 Note: A PROTOCOL is a set of rules and procedures for regulating data transmission between computers, and between testing equipment and computers. Now five different types of protocols (ISO 9141, Keyword 2000, J1850 PWM, J1850 VPW and CAN) are in use by vehicle manufacturers.

Tap “OK” to enter the diagnostic test modes selection screen.

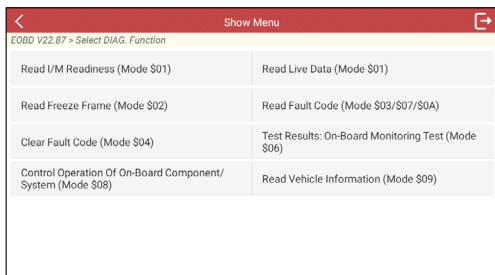

 Note: Diagnostic Test Modes as described in the latest OBD II standard SAE J1979. Not all Modes are supported by all vehicles.

\$01 - Request Current Powertrain Diagnostic Data

\$02 - Request Powertrain Freeze Frame Data

\$03 - Request Emission-Related Stored DTCs

\$04 - Clear/Reset Emission-Related Diagnostic Information

\$05 - Request Oxygen Sensor Monitoring Test Results (2007 and older vehicles only)

\$06 - Request On-Board Monitoring Test Results for Specific Monitored Systems

\$07 - Request Emission-Related Stored DTCs Detected During Current or Last Completed Driving Cycle

\$08 - Request Control of On-Board System, Test or Component

\$09 - Request Vehicle Information

\$0A - Request Emission-Related Permanent DTCs

It mainly includes the following functions:

1. Read Codes

This option is used to identify which section of the emission control system has malfunctioned.

2. Erase Codes

After reading the retrieved codes from the vehicle and certain repairs have been carried out, you can use this function to erase the codes from the vehicle. Before performing this function, please be sure the vehicle's ignition key is in the ON position with the engine off.

Notes:

- Before performing this function, make sure to retrieve and record the trouble codes.
 - After clearing, you should retrieve trouble codes once more or turn ignition on and retrieve codes again. If there are still some trouble codes in the system, please troubleshoot the code using a factory diagnosis guide, then clear the code and recheck.
-

3. I/M Readiness

I/M refers to Inspection and Maintenance that is legislated by the Government to meet federal clean-air standards. I/M Readiness indicates whether or not the various emissions-related systems on the vehicle are operating properly and are ready for Inspection and Maintenance testing.

The purpose of the I/M Readiness Monitor Status is to indicate which of the vehicle's Monitors have run and completed their diagnosis and testing (as described in Chapter 2.5), and which ones have not yet run and completed testing and diagnosis of their designated sections of the vehicle's emissions system.

The I/M Readiness Monitor Status function also can be used (after repair of a fault has been performed) to confirm that the repair has been performed correctly, and/or to check for Monitor Run Status.

4. Data Stream

This option retrieves and displays live data and parameters from the vehicle's ECU.

5. View Freeze Frame

When an emission-related fault occurs, certain vehicle conditions are recorded by the on-board computer. This information is referred to as freeze frame data. Freeze Data is a snapshot of the operating conditions at the time of an emission-related fault.

 Note: If DTCs were erased, Freeze Data may not be stored in vehicle memory depending on vehicle.

6. O2 sensor test

The results of O2 sensor test are not live values but instead the results of the ECU's last O2 sensor test. For live O2 sensor readings, refer to any of the live sensor screens such as Graph Screen.

Not all test values are applicable to all vehicles. Therefore, the list generated will vary depending on vehicle. In addition, not all vehicles support the Oxygen Sensors screen.

7. On-board monitor test

This function can be utilized to read the results of on-board diagnostic monitoring tests for specific components/systems.

8. EVAP System Test

The EVAP test function lets you initiate a leak test for the vehicle's EVAP system. The tool does not perform the leak test, but signals to vehicle's on-board computer to initiate the test. Before using the system test function, refer to the vehicle's service repair manual to determine the procedures necessary to stop the test.

9. Vehicle Info

This option displays the vehicle information, such as VIN (Vehicle Identification Number), CID (Calibration ID) and CVN (Calibration Verification Number).

4.4 History

Generally once a vehicle diagnosis is performed, the tool will record the every details of diagnostic session. The History function provides direct access to the previously tested vehicles and users can resume from the last operation, without starting from scratch.

Tap **History** on the Diagnose main menu screen, all diagnostic records will be listed on the screen in date sequence.

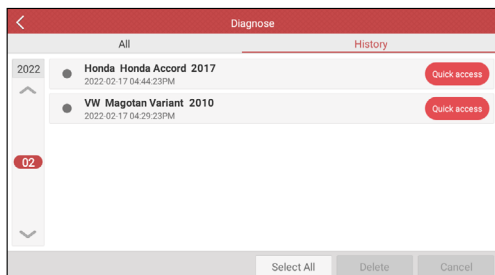

- Tap certain vehicle model to view the details of the last diagnostic report.
- To delete certain diagnostic history, select it and then tap **Delete**. To delete all historical records, tap **Select All** and then tap **Delete**.
- Tap **Quick access** to directly navigate to the function selection page of last diagnostic operation. Choose the desired option to proceed.

5 Reset

In addition to amazing & powerful diagnostic function, the tool also features various service functions.

It offers coding, reset, relearn and more service functions, to help vehicles get back to functional status after repair or replacement. Available tests vary by vehicle manufacturer, year, and model.

There are two methods to reset service lamp: Manual Reset or Auto Reset. Auto Reset follows the principle of sending command from the tool to vehicle's ECU to do resetting. While using Manual Reset, users just follow the on-screen instructions to select appropriate execution options, enter correct data or values, and perform necessary actions, the system will guide you through the complete performance for various service operations.

Follow the flowchart shown as below to perform resetting.

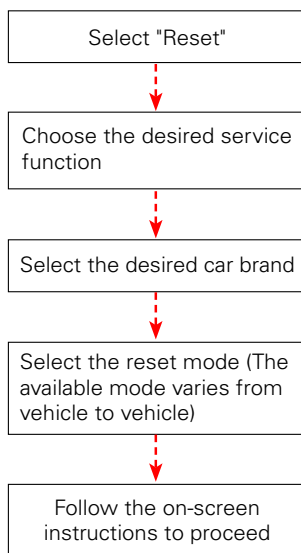

5.1 Oil Reset Service

This function enables you to reset the oil service for the engine oil life system, which calculates an optimal oil life change interval depending on the vehicle

driving conditions and weather events.

It needs to be performed in the following cases:

1. If the service lamp is on, run car diagnostics first for troubleshooting. After that, reset the driving mileage or driving time, so as to turn off the service lamp and enable a new driving cycle.
2. If the service lamp is not on, but you have changed the engine oil or electric appliances that monitor oil life, you need to reset the service lamp.

5.2 Electronic Parking Brake Reset

This function enables you to reset the brake pad after replacing the brake pad.

It needs to be performed in the following cases:

1. The brake pad and brake pad wear sensor are replaced.
2. The brake pad indicator lamp is on.
3. The brake pad sensor circuit is short, which is recovered.
4. The servo motor is replaced.

5.3 Steering Angle Calibration

This function enables you to reset the steering angle, after replacing the steering angle position sensor, replacing steering mechanical parts (such as steering gearbox, steering column, end tie rod, steering knuckle), performing four-wheel alignment, or recovering car body.

To reset the steering angle, first find the relative zero point position for the car to drive in straight line. Taking this position as reference, the ECU can calculate the accurate angle for left and right steering.

5.4 ABS Bleeding

This function allows you to perform various bi-directional tests to check the operating conditions of Anti-lock Braking System (ABS).

It needs to be performed in the following cases:

1. When the ABS contains air.
2. When the ABS computer, ABS pump, brake master cylinder, brake cylinder, brake line, or brake fluid is replaced.

5.5 Gear Learning

This function enables you to perform tooth learning for the car, to turn off the

MIL.

It needs to be performed in the following cases:

1. After the engine ECU, crankshaft position sensor, or crankshaft flywheel is replaced.
2. The DTC 'tooth not learned' is present.

5.6 IMMO Service

This function enables you to perform the anti-theft key matching function, so that the immobilizer control system on the car identifies and authorizes remote control keys to normally use the car.

It needs to be performed in the following cases:

When the ignition switch key, ignition switch, combined instrument panel, ECU, BCM, or remote control battery is replaced.

5.7 Injector Coding

This function enables you to write injector actual code or rewrite code in the ECU to the injector code of the corresponding cylinder, so as to more accurately control or correct cylinder injection quantity.

It needs to be performed in the following cases:

After the ECU or injector is replaced.

5.8 Battery Maintenance System Reset

This function enables you to perform a resetting operation on the monitoring unit of vehicle battery, in which the original low battery fault information will be cleared and battery matching will be done.

It needs to be performed in the following cases:

1. The main battery is replaced.
2. The battery monitoring sensor is replaced.

5.9 Diesel Particulate Filter (DPF) Regeneration

This function enables you to clear PM (Particulate Matter) from the DPF filter through continuous combustion oxidation mode (such as high temperature heating combustion, fuel additive or catalyst reduce PM ignition combustion) to stabilize the filter performance.

It needs to be performed in the following cases:

1. The exhaust back pressure sensor is replaced.
2. The PM trap is removed or replaced.
3. The fuel additive nozzle is removed or replaced.
4. The catalytic oxidizer is removed or replaced.
5. The DPF regeneration MIL is on and maintenance is performed.
6. The DPF regeneration control module is replaced.

5.10 Electronic Throttle Position Reset

This function enables you to make initial settings to throttle actuators and returns the learned values stored on ECU to the default state. Doing so can accurately control the actions of regulating throttle (or idle engine) to adjust the amount of air intake.

5.11 Gearbox Matching

This function enables you to complete the gearbox self-learning to improve gear shifting quality.

It needs to be performed in the following cases:

When the gearbox is disassembled or repaired.

5.12 AFS (Adaptive Front-lighting System) Reset

This function enables you to initialize the adaptive headlamp system.

5.13 Sunroof Initialization

This function enables you to set the sunroof lock off, closed when it rains, sliding / tilting sunroof memory function, temperature threshold outside the car etc.

5.14 Suspension Calibration

This function enables you to adjust the height of the body.

It needs to be performed in the following cases:

1. When replacing the body height sensor, or control module in the air suspension system.
2. When the vehicle height is incorrect.

5.15 EGR Adaption

This function is used to learn the EGR (Exhaust Gas Recirculation) valve after it is cleaned or replaced.

5.16 Seats Calibration

This function is applied to match the seats with memory function that are replaced and repaired.

5.17 Tyre Reset

This function is used to set the size parameters of the modified or replaced tire.

5.18 Coolant Bleed

Use this function to activate the electronic water pump before venting the cooling system.

5.19 AdBlue Reset (Diesel Engine Exhaust Gas Filter)

After the diesel exhaust treatment fluid (car urea) is replaced or filled up, urea reset operation is required.

5.20 NOx Sensor Reset

NOx sensor is a sensor used to detect the content of nitrogen oxides (NOx) in engine exhaust. If the NOx fault is re-initialized and the NOx catalytic converter is replaced, it is necessary to reset the catalytic converter learned value stored in the engine ECU.

5.21 AC System Initialization

AC system relearn/initialization must be performed when the vehicle AC ECU or actuator is replaced or the ECU memory is lost.

5.22 High Voltage Battery Detection

This function is used for high voltage battery diagnosis and status information detection.

5.23 Windows Calibration

This function is used to perform door window matching to recover the ECU initial memory, and recover the automatic ascending and descending function of power window.

5.24 Language Change

This function is used to change system language of vehicle center console.

5.25 A/F Reset

This function is applied to set or learn air/fuel rate parameters.

5.26 Transport Mode

To lower vehicle power consumption, user may perform the following operations: limit vehicle speed, not wake up the network for door open and disable remote key etc. In this case, deactivating transport mode is needed to recover vehicle being normal.

5.27 Stop/Start Reset

This function is used to open or close the automatic Start/Stop function via setting the hidden function in ECU (The precondition is vehicle equipped with hidden function and hardware support).

5.28 Intelligent Cruise Control System Reset

This function is used to matching the intelligent cruise control module after it is replaced or repaired.

5.29 Engine Power Balance Monitoring

This function is used to monitor crankshaft acceleration in the power stroke of each cylinder, to determine the relative power provided by each cylinder.

5.30 Gas Particulate Filter (GPF) Regeneration

This function is used to perform the GPF replacement or regeneration after the

fuel consumption is increased and engine output power is reduced resulting from a long time service of the GPF.

5.31 Motor Angle Calibration

This function is used to perform the motor angle calibration when the rotor position detected by the motor angle position sensor is different from the actual rotor field position.

6 Data

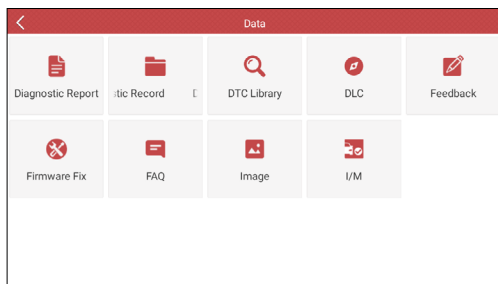

6.1 Diagnostic Report

This module stores all diagnostic reports generated in process of vehicle diagnosis.

All the diagnostic reports are sorted by Date and Make. If there are too many reports stored, tap  (Search) to filter and quickly locate it.

- To select certain report, just check the box at the right lower corner of the report. To select all reports, tap “Select All”. To deselect all, tap “Unselect”.
- Tap it to view its details.
- Select the desired report and then tap “Delete” to delete it.

6.2 Diagnostic Record

If user records the running parameters or waveform graphs while reading data stream, it will be saved as diagnostic records and appear under this tab.

Tap “Diagnostic Record” to enter and select the desired data stream items and tap “OK” to jump to the playback page.

On-screen Buttons:

Graph – displays the parameters in waveform graphs.

Combine – this option is mostly used in graph merge status for data comparison. In this case, different items are marked in different colors.

Value – this is the default mode which displays the parameters in texts and shows in list format.

Frame Playback – plays back the recorded data stream items frame by frame. Once it is in frame playback mode, this button changes into “Auto Playback”.

6.3 DTC Library

This option allows you to retrieve the detailed definition of certain DTC from the DTC database.

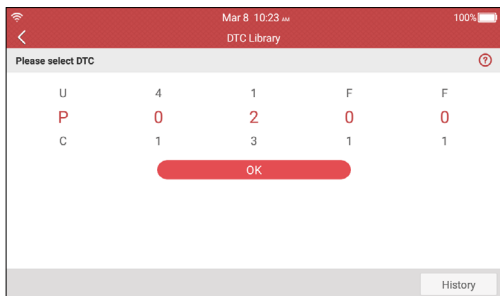

Swipe the screen upwards/downwards to alter the value, then press [OK] button, the screen will display definition of the DTC.

6.4 DLC(Data Link Connector) Location

This option helps you to find the location of the vehicle's DLC.

6.5 Feedback

This item allows you to feedback your diagnostic problems to us for analysis and troubleshooting.

Tap "Feedback", the following 3 options will be displayed on the left column of the screen.

A. Feedback

Tap a tested vehicle model to enter the feedback screen.

- 1) Tap "Choose File" to open the target folder and choose the desired diagnostic logs.
- 2) Choose the failure type and fill in the detailed failure description in the blank text box and telephone or email address. After inputting, tap "Submit Result" to send it to us.

B. History

Tap it to view all diagnostic feedback records. Different process states are marked with different colors.

C. Offline list

Tap it to display all diagnostic feedback logs which have not been submitted successfully due to network failure. Once the tool gets a stable network signal, it will be uploaded to the remote server automatically.

6.6 Firmware Fix

Use this item to upgrade and fix diagnostic firmware. During fixing, please do not cut power or switch to other interfaces.

6.7 FAQ

Lists some frequently asked questions and answers related to this tool.

6.8 Image

This option allows you to manage or share the screenshots.

6.9 I/M

This option allows you to check whether or not the various emissions-related systems on the vehicle are operating properly and are ready for Inspection and Maintenance testing.

Monitor	Value
Misfire	✘ Unsupported
Fuel System	✔ Completed
Comprehensive Component	⚠ Not Ready
Catalyst	✘ Unsupported

Report

7 Upgrade

If some new software or APK can be updated, a numeric indicator will display on the **Upgrade** module on the Job menu. In this case, you may use this option to keep it synchronized with the latest version.

Notes:

- To enjoy more functions and better service, you are strongly suggested to update it on regular basis.
- This function requires a stable network connection.

Tap **Upgrade** on the Job menu to enter the update center.

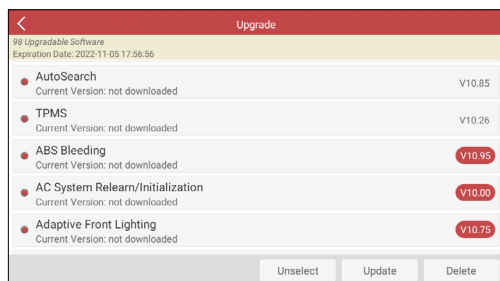

By default, all diagnostic software is selected.

To deselect certain software, tap **Unselect**, and then check the box next to vehicle model.

Tap **Update** to start downloading. It may take several minutes to finish it, please be patient to wait. To pause downloading, tap **Stop**. To resume it, tap **Continue**. If network connection failure occurs, tap **Retry** to try again.

Once download is finished, the software packages will be installed automatically.

8 Mall

This function allows you to subscribe other vehicle diagnostic software and reset software that are not pre-installed on the tool.

All diagnostic software in the mall covers full systems and full functions (excluding online programming and coding etc). Different vehicle software is tagged with different price.

Tap "Mall" to open the online software store. Select the target software and follow the on-screen instructions to finish the transaction.



Note: The software service belongs to the virtual goods. It becomes immediately effective from the date of the successful transaction and it does not accept the refund. When making payment, please double check the order information.

The subscribed software can be free to use for one year. After it expires, it will become disabled and user needs to renew the subscription to activate it.

9 FAQ

Here we list some frequently asked questions and answers related to this tool.

① System halts when reading data stream. What is the reason?

It may be caused by a slackened connector. Please turn this tool off, firmly connect the connector, and switch it on again.

② Screen of main unit flashes at engine ignition start.

Caused by electromagnetic disturbing, and this is normal phenomenon.

③ There is no response when communicating with on-board computer.

Please confirm the proper voltage of power supply and check if the throttle has been closed, the transmission is in the neutral position, and the water is in proper temperature.

④ What to do if the system fails to start auto VIN detection?

Please check the following possible reasons:

- Whether the tool is properly connected to the vehicle's DLC.
- Whether the "Automatic detection on Connect" switch is OFF. If yes, slide it to ON.

⑤ Why are there so many fault codes?

Usually, it's caused by poor connection or fault circuit grounding.

⑥ How to upgrade the system software?

1. Switch the tool on and ensure a stable internet connection.
2. Tap "Setting" on the Job Menu, select "About" -> "Version", and tap "Detect the System Version" to enter the system upgrading page.
3. Follow the on-screen instructions step by step to finish the process. It may take several minutes depending on the internet speed, please be patient. After upgrade is successfully finished, the tool will automatically restart and enters the Job menu.

⑦ What if the tool cannot be switched on even after a period of recharging?

Please recharge it for at least 3 hours until the power LED lights up, then it can be switched on.

Warranty

THIS WARRANTY IS EXPRESSLY LIMITED TO PERSONS WHO PURCHASE LAUNCH PRODUCTS FOR PURPOSES OF RESALE OR USE IN THE ORDINARY COURSE OF THE BUYER'S BUSINESS.

LAUNCH electronic product is warranted against defects in materials and workmanship for one year (12 months) from date of delivery to the user.

This warranty does not cover any part that has been abused, altered, used for a purpose other than for which it was intended, or used in a manner inconsistent with instructions regarding use. The exclusive remedy for any automotive meter found to be defective is repair or replacement, and LAUNCH shall not be liable for any consequential or incidental damages.

Final determination of defects shall be made by LAUNCH in accordance with procedures established by LAUNCH. No agent, employee, or representative of LAUNCH has any authority to bind LAUNCH to any affirmation, representation, or warranty concerning LAUNCH automotive meters, except as stated herein.

Order Information

Replaceable and optional parts can be ordered directly from your LAUNCH authorized tool supplier. Your order should include the following information:

1. Quantity
2. Part number
3. Item description

Customer Service

If you have any questions on the operation of the unit, please contact local dealer, or contact LAUNCH TECH CO., LTD:

Tel: 86-755-25938674

E-mail: DOD@cnlaunch.com

Statement: LAUNCH reserves the rights to make any change to this manual without notice. We have tried our best to make the descriptions and illustrations in the manual as accurate as possible, and defects are inevitable, if you have any question, please contact local dealer or LAUNCH TECH CO., LTD., LAUNCH does not bear any responsibility arising from misunderstandings.