

CONDOR

Automatic Key Cutting Machine
XC-MINI PLUS

User Manual

V2.0

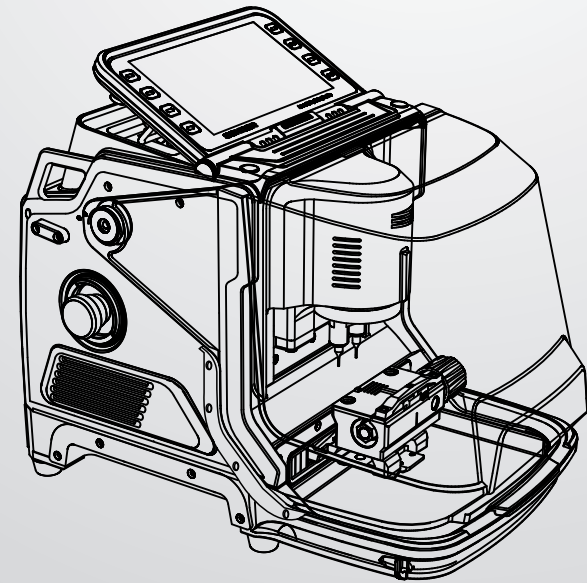

TABLE OF CONTENTS



XC-MINI PLUS
Automatic Key Cutting Machine

1	Safety precautions and warnings	02
2	Machine information	03
3	Product packaging checklist	04
4	Overview	
4.1	Structure diagram	06
4.2	Characteristics	07
4.3	Specification	07
5	Installation instruction	
5.1	Cutter installation	08
5.2	Cutter uninstallation	09
5.3	Clamp installation	10
5.4	Pictures of clamps	11
5.5	Clamp M2 sides selection	12
5.6	Clamp M4 instruction	13
6	Operation instructions	
6.1	Height level adjustment	14
6.2	Clamp calibration	16
6.3	Cutting calibration	19
6.4	How to use the key database	21
6.5	How to use key duplication	24
6.6	How to use universal type	27
6.7	How to use cut by bitting	31
6.8	How to use find bitting	35
7	Online update	38
8	Maintenance	40
9	After-sale description	40

1. Safety precautions and warnings

To avoid injuries to operators and damages to the machine, please read this product user manual carefully before you start, and follow the safety notes shown below:

- Always use the machine under safe environment.
- Wear protective goggles that are in line with ANSI standard.
- Put down the protective shield when the machine is working.
- Do not have clothes, hair, hands and other tools close to the machine when it is working.
- DO not leave the machine unattended when it is working.
- Do not use a damaged or loose socket.
- Unplug the machine when it is not in use for a long time.
- Do not put the machine in a place that is damp, greasy and dusty.
- Do not put things like tool or containers on the machine.
- Put the machine on a flat and firm surface .
- Keep the machine dry and clean.
- Unplug the machine under unusual circumstance.







2. Machine information









Dear customers, thank you for choosing XC-MINI PLUS automatic key cutting machine. We are confident that this product will improve your work efficiency with great convenience. This product user manual provides operating instructions for you to use the machine correctly and safely. To avoid injuries and financial loss, please carefully read this manual through before you start to operate the machine. And we kindly remind you to keep this manual properly for future reference.

- 1) The images and colors of the machine shown in this user manual is indicative only. If there is inconsistency between the images and actual products, the actual products prevail.
- 2) Warranty is 3 years if the use of the machine is under normal condition.
- 3) Within Warranty, free maintenance and repairing is not provided if the machine becomes dysfunctional due to the following reasons:
 - Operation without referring to or violating the user manual.
 - Modifications or repairs to the machine by individuals.
 - Falling, knocking or wrong voltage.
 - Force majeure.
 - Use of the machine in bad condition for long time or put machine into vehicles or ships caused damage.
 - Damaged or worn-out plastic case and protective shield due to frequent use.

3. Product packaging checklist

CONDOR XC-MINI PLUS should come with accessories listed in the following table. Please have a check when you get this product and contact your distributor if anything in the table is missing.

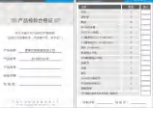
Name	Sample picture	quantity	Description
Machine		1	Key cutting machine
2.5mm cutter		1	Cutting tool (Ø2.5xØ6x40L)
1.5mm cutter		1	Cutting tool (Ø1.5xØ6x40L)
Probe		2	Probing tool (Ø1.0xØ6x40L)
2mm hexagon bar wrench		1	Changing probes and cutters, keys fixation
1.5m Power cord of China standard		1	connect to power
1.5m Power cord of UK standard(Optional)		1	connect to power
1.5m Power cord of US standard(Optional)		1	connect to power
1.5m Power cord of EU standard(Optional)		1	connect to power
USB cable		1	Tool of connecting machine with computer

Brush		1	Cleaning tool
Clamp M1 and link stopper		1	Cutting clamp
Clamp M2 and shim		1	Cutting clamp
Clamp M3 (Optional)		1	FO21/SX9 key clamp
Clamp M4 (Optional)		1	Household key clamp
Power supply adaptor (Optional)		1	Power supply
Product quality certificate		1	Factory inspection report and packing list
User manual		1	Machine assembly/adjustment/operation instruction

Notes:

- Replace cutters regularly to ensure cutting efficiency.
- Check the synchronous belt of stepper motor regularly and replace the worn-out ones in time for a good cutting force and precision.
- Please use a 10A fuse .

4. Overview

4.1 Structure diagram



4.2 Characteristics

- Build-in database
- 0-90° angle selection 7 inch capacitive touch screen
- 3-Axis ball screw transmission
- Cross rail, high stability
- Aluminum structure, larger space for putting flip keys
- Strengthened air tightness effectively prevents metal scraps from entering into the machine
- Cutter and probe work in parallel
- Support clamps M1 (standard equipped) /M2 (standard equipped) /M3 (optional)/M4 (optional)
- Support online update
- Support Sided/Track/Dimple/Tibbe key

4.3 Specification

Input voltage	90-264 VAC
Input frequency	47-63 Hz
Power	200 W
Package size	515 x 480 x 380 mm
Machine size	250 x 413 x 300 mm
LED screen resolution	1024 x 600
Principal axis Rotation speed	9000 rpm
USB port	USB 2.0
Working temperature	0-50 C
Humidity	10-90%
Net weight	19 Kg
Gross weight	24 Kg

5. Installation instruction

5.1 Cutter installation

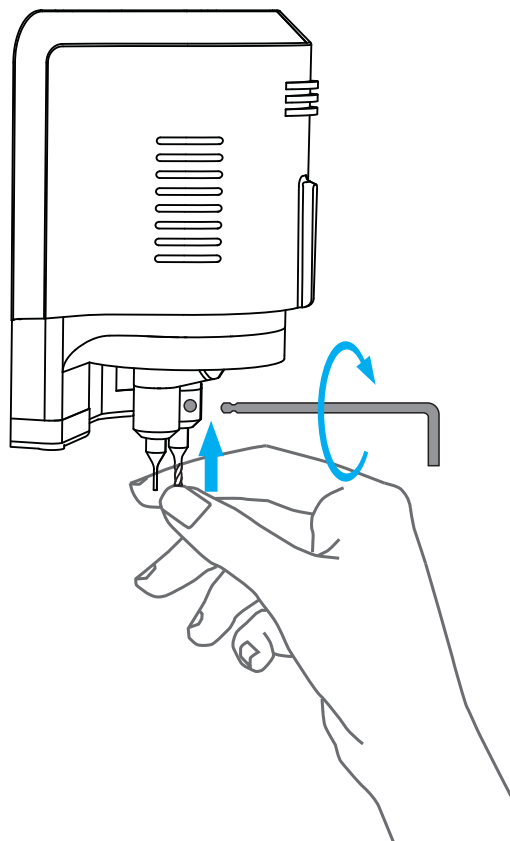

Installation steps:

- 1) Put the cutter into the mounting hole and make sure the cutter goes to the limit of top.
- 2) Use the cutter tightening wrench to clockwise fix the cutter.

5.2 Cutter uninstallation

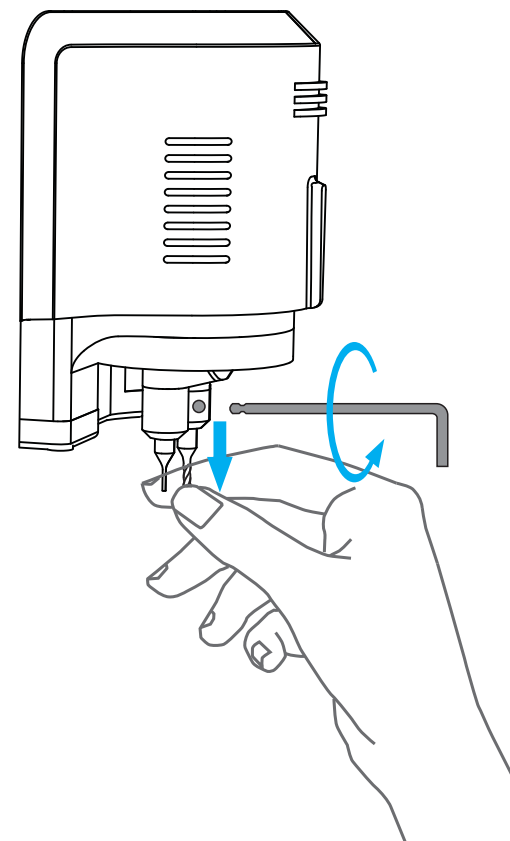

Uninstallation steps:

- 1) Counter-clockwise unscrew the cutter manually.
- 2) Take the cutter off when it is loose.

5.3 Clamp installation

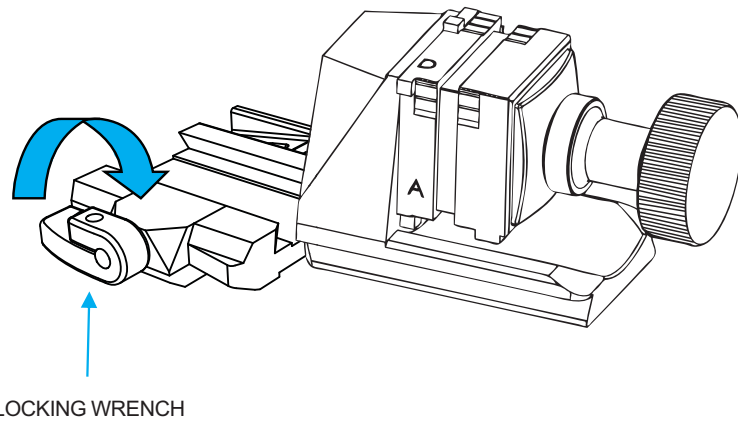

Installation steps:

- 1) Loosening the clamp tightening wrench by turning it counter-clockwise to the left.
- 2) Select the correct clamp and slide in the clamp to the clamp holder and push it to the limit of left.
- 3) After the clamp is put in the clamp platform, turn the clamp tightening wrench clockwise for fix it.

5.4 Pictures of clamps



Clamp M1
Support type (as picture below)

Standard single/double sided key

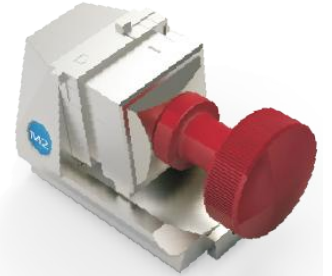

Clamp M2
Support type (as picture below)

4 Track external	2 Track external	4 Track internal
Channel track	Dimple keys	



Clamp M3

Support type (FO21 example)	Support type (SX9 example)
FO21	SX9



Clamp M4
Support type (as picture below)

	+

5.5 Clamp M2 sides selection

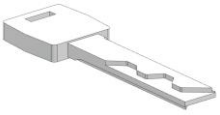
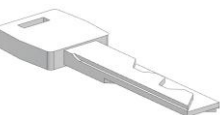
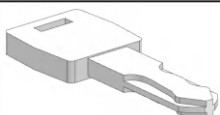
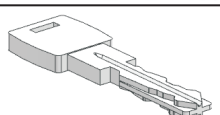
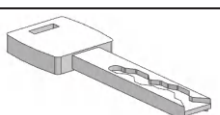
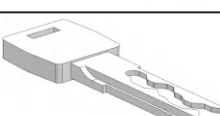
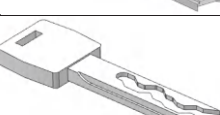
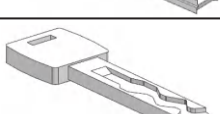
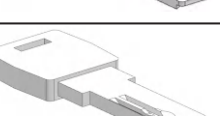
Key types	Cutting side pictures	Clamp cutting sides	Description
2 Track external		A/C	1) A side and D side work for the same types of keys, please select it according to the cutting depth 2) Dimple keys need different special cutter
		A/B	
4 Track external		A/D	
		A/D	
Channel track		A/D	
		A/C	
		A/B	
4 Track internal		A/D	
Dimple keys		A/D	

5.6 Clamp M4 instruction



Clamp M4 for household keys, mainly support standard single and double sided keys, also for crucifix keys, example as follows:



Sided keys

Crucifix keys

6. Operation instructions

Machine needs to initialize on first use. Please do as following steps:

6.1 Height level adjustment



1) Enter main interface and click on 'Self Test'.

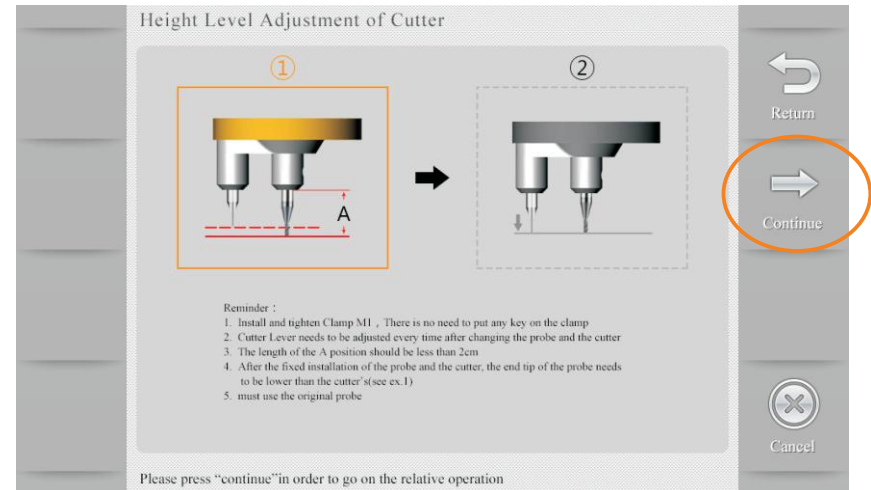

3) Adjust the height of cutter and probe by following the tips on the screen, then click on 'Continue' to the step of adjustment.



2) Click on 'Height Level Adjustment'.

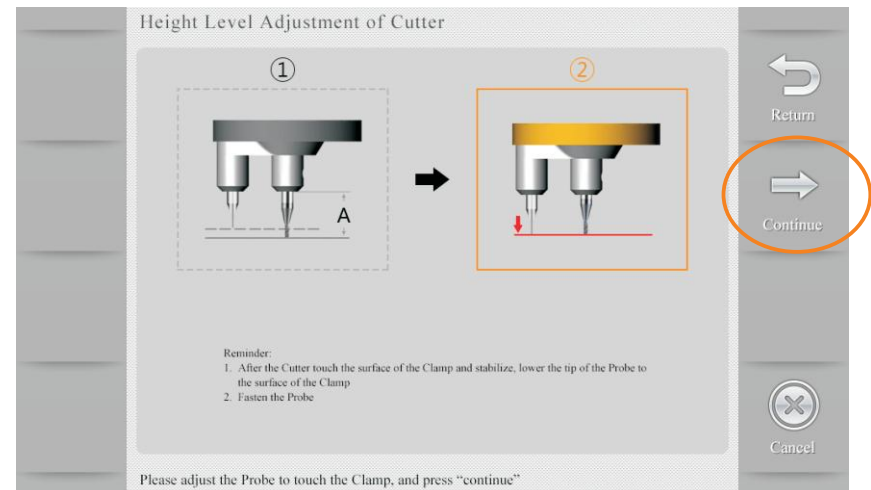

4) After machine stopped, please follow the screen tips, adjust the probe, let it at same height with cutter, then 'Continue'.

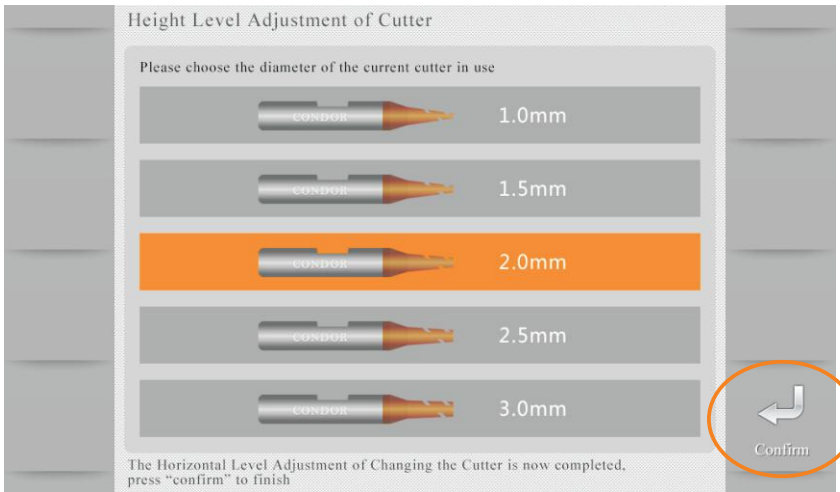

5) Select the correct diameter of cutter and confirm it.

6.2 Clamp calibration



1) Enter main interface and click on ' Self Test'.

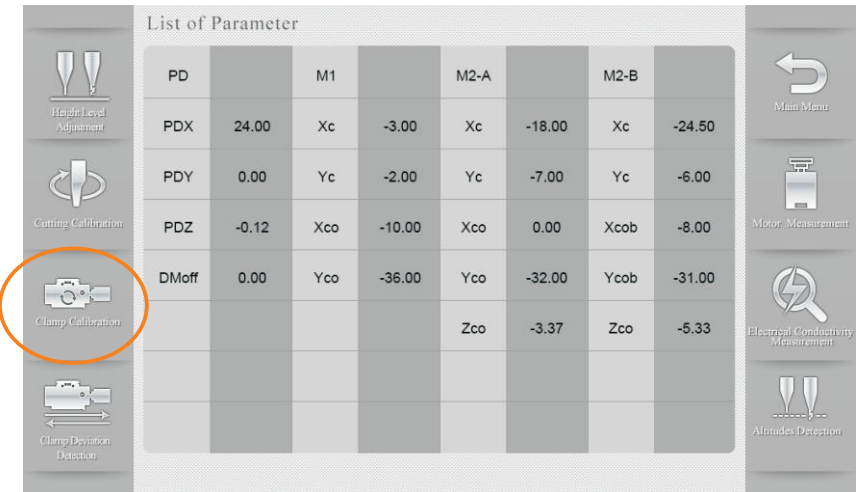

2) Click on 'Clamp Calibration'.



3) Select clamp M1 and proceed by following the tips on the screen.

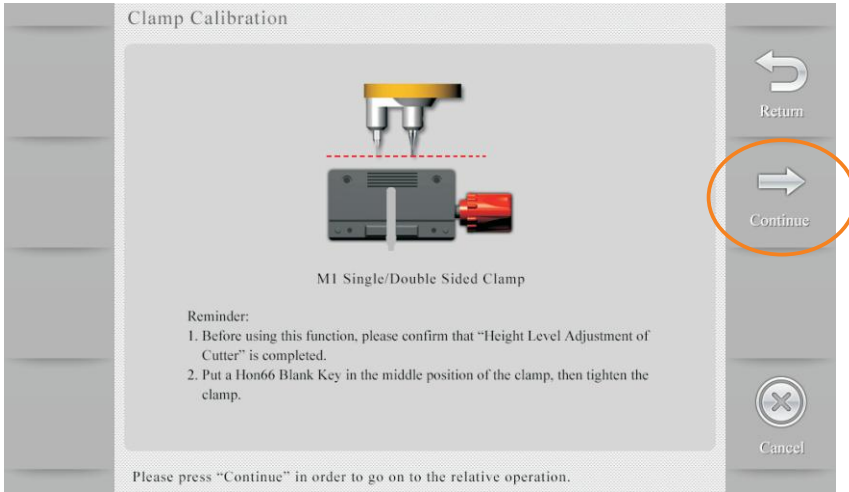

4) Please put the HON66 key blank according to the screen, then tighten the clamp, click on 'Continue', calibration finished.

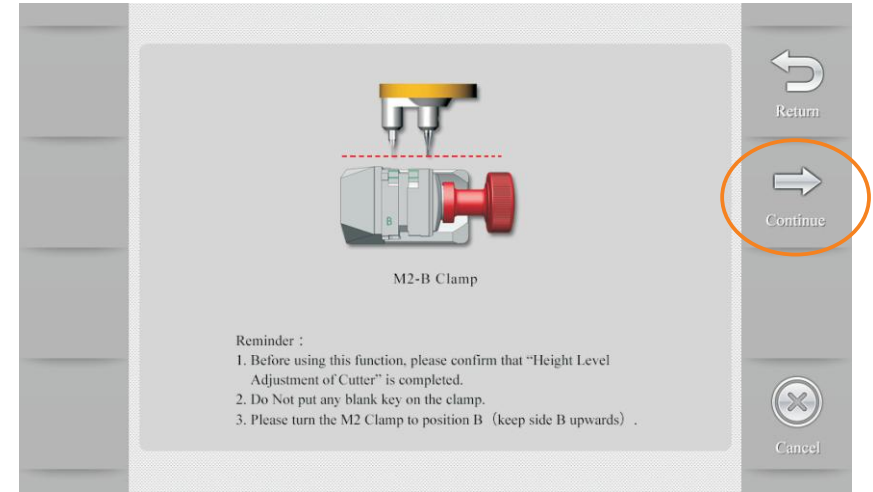

6) Follow the tips on the screen, rotate side B, C, D upward one by one to calibration until M2 clamp calibration finished.

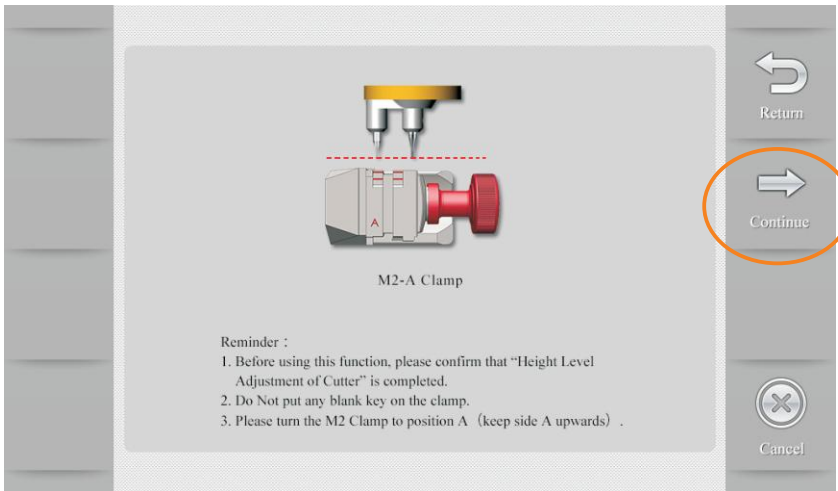

5) Enter clamp M2 calibration, rotate side A upward and do not put any keys on the clamp.

6.3 Cutting calibration



1) Enter main interface and click on 'Self Test'.

List of Parameter

PD	M1	M2-A	M2-B
PDX 24.00	Xc -3.00	Xc -18.00	Xc -24.50
PDY 0.00	Yc -2.00	Yc -7.00	Yc -6.00
PDZ -0.12	Xco -10.00	Xco 0.00	Xcob -8.00
DMoff 0.00	Yco -36.00	Yco -32.00	Ycob -31.00
	Zco -3.37	Zco -5.33	

2) Click on 'Cutting Calibration'.

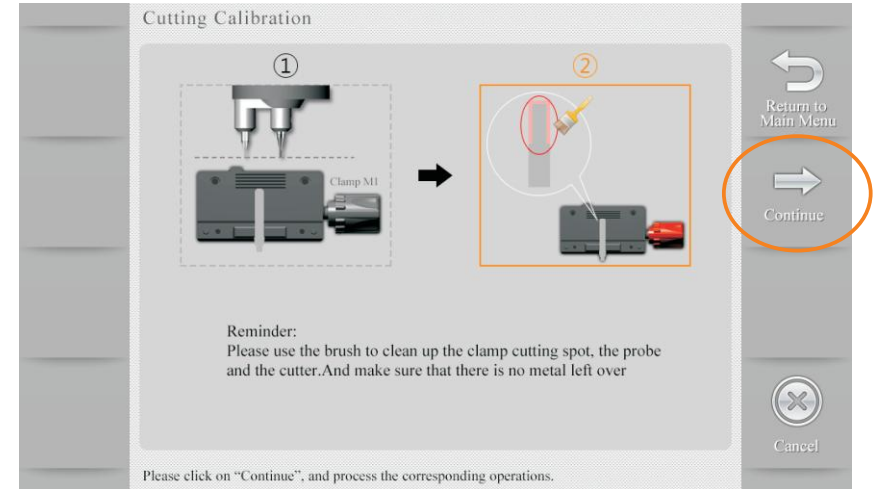

4) Clean the cutter/probe/clamp cutting area by brush. Click on 'Continue' and calibration has finished.

6.4 How to use the key database

Three ways to make keys from the key database.

1. Customers provide key code .
2. Some car keys have key code information on lock .
3. Other ways to get key code.

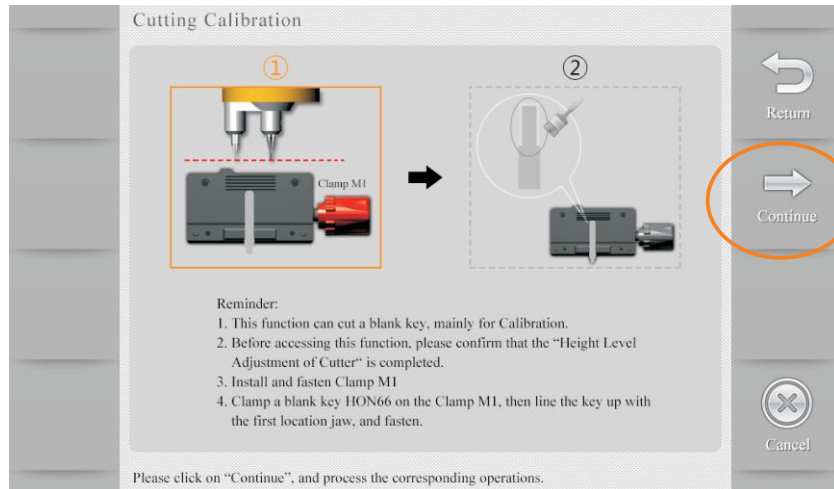

3) Operate by following the tips and click on 'Continue'.
*Please use new key blank, used HON66 will not working for cutting calibration.



1) Click on 'Key Database' and select or input car maker.

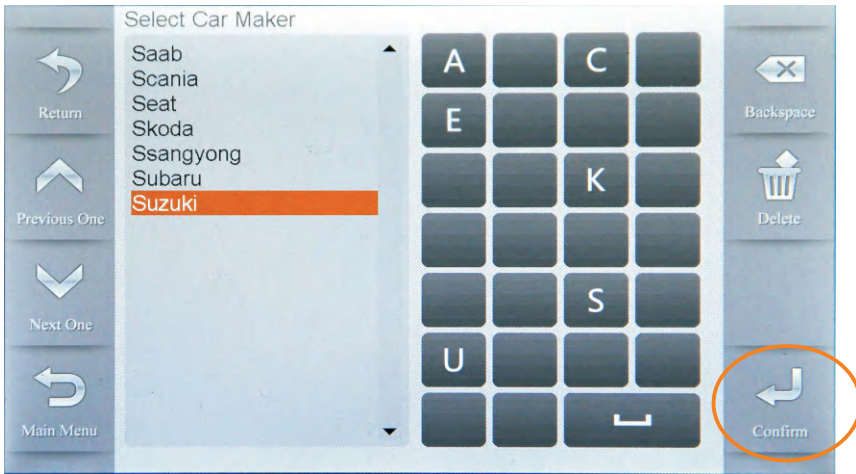

2) Click on 'Confirm' to the next page.

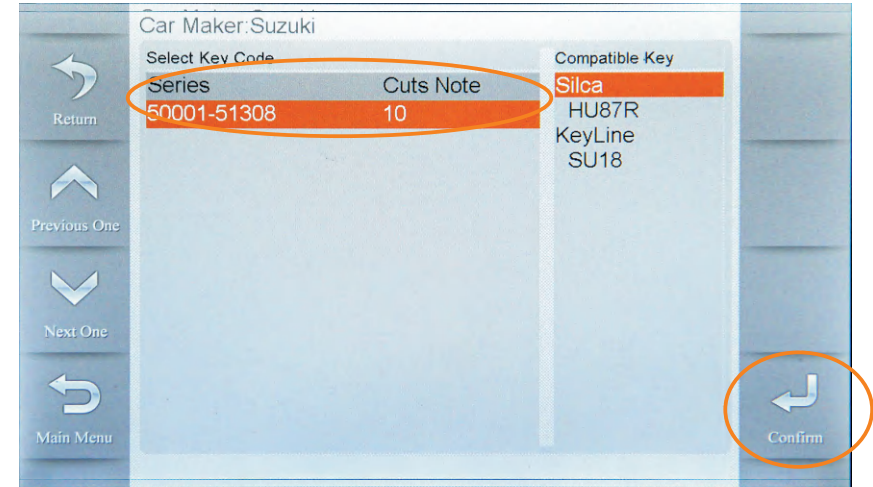

4) Select the key series and click 'Confirm'.



3) Enter the key code (the key code is printed on the lock for some cars) and click 'Confirm'.

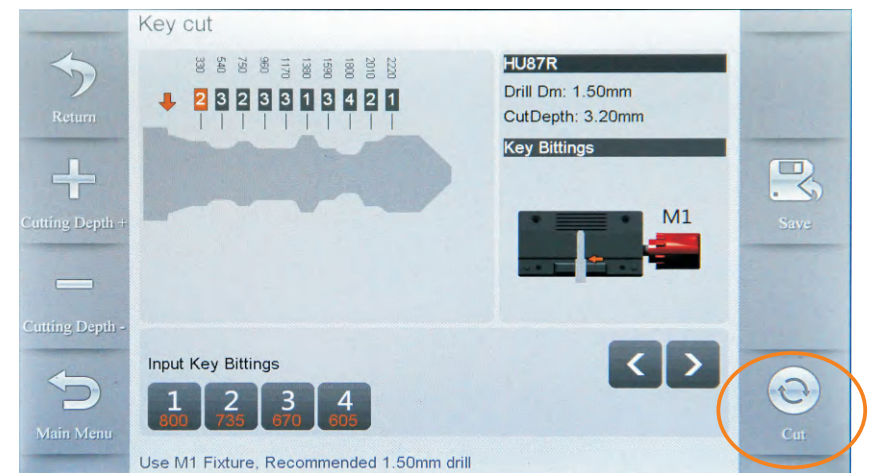

5) The key bittings will be automatically generated and shown on the screen, click 'Cut' to cut.

6.5 How to use key duplication

Car models and years are needed for key duplication



1) Click on 'Key Duplication'.

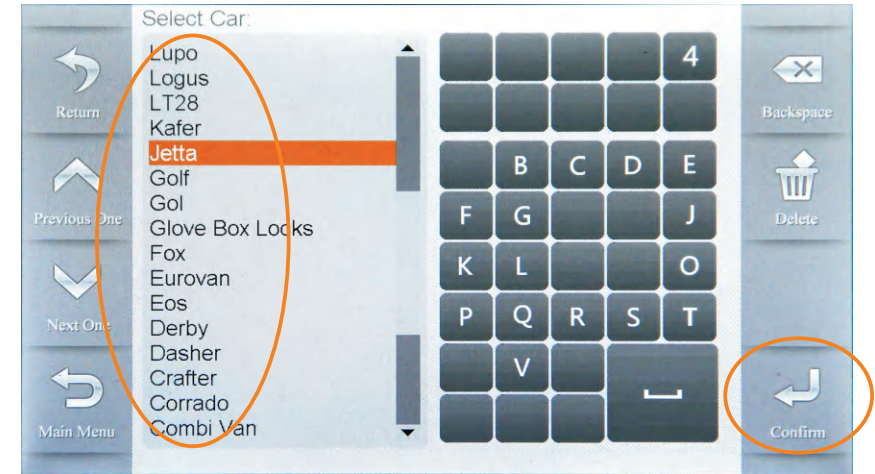

3) Select the car maker and click on 'Confirm'.

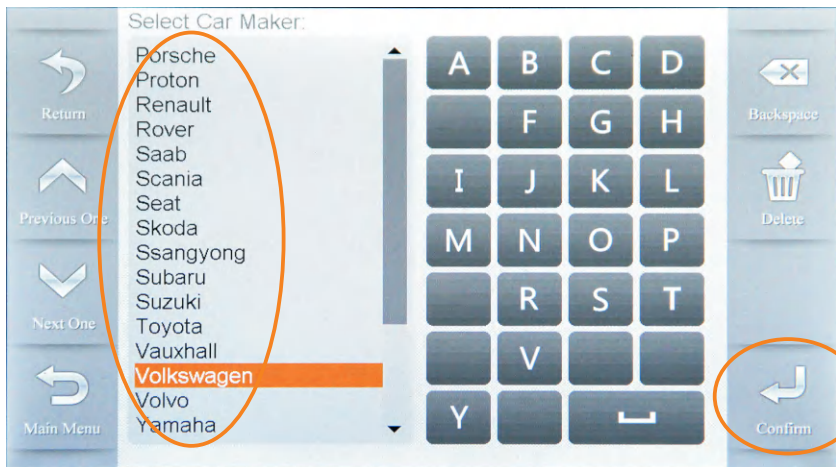

2) Select or enter the car maker.

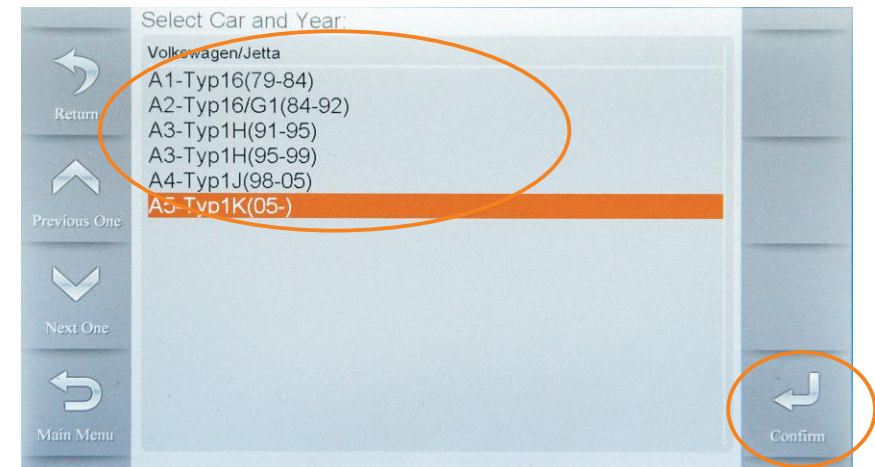

4) Select the car model and year, click on 'Confirm'.

6.6 How to use universal type

There is no need that customers know the exact flat, space and other values for the key, just duplicate same shape as original key, then cut key .

Instructions:



5) Follow the tips on screen and correctly put the key on the clamp, click 'Key Decode'.



1) Click on 'Key Duplication'.

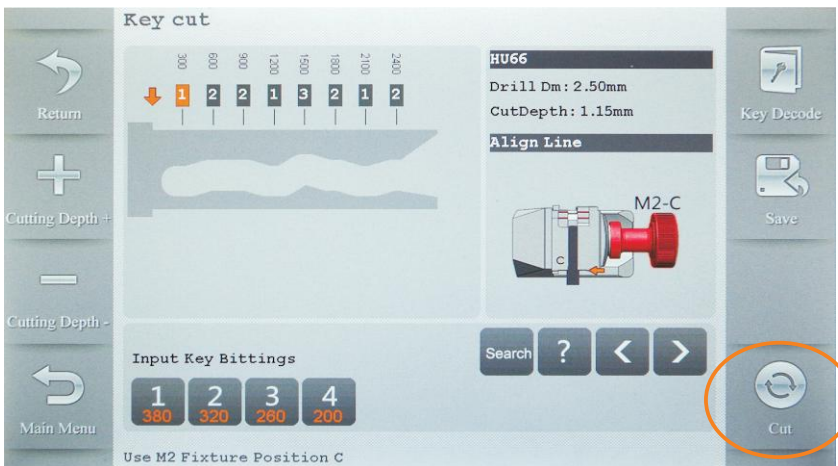

6) After decode successful, click on 'Cut'.

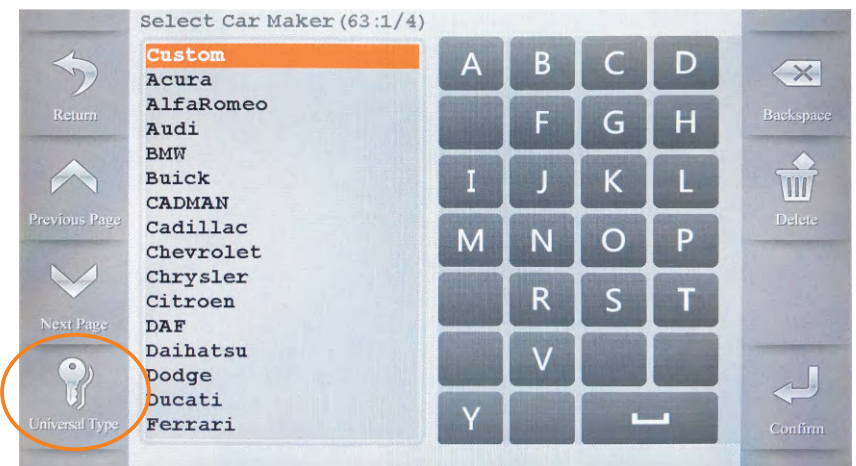

2) Click on 'Universal Type'.

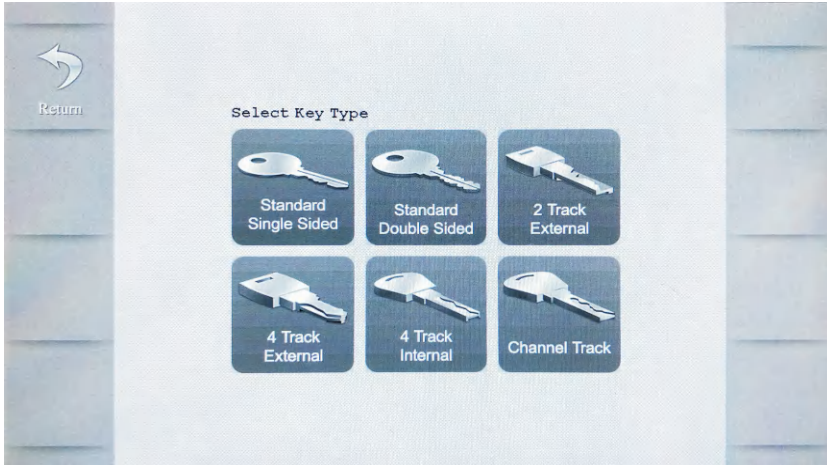

3) Select key type according to original key.

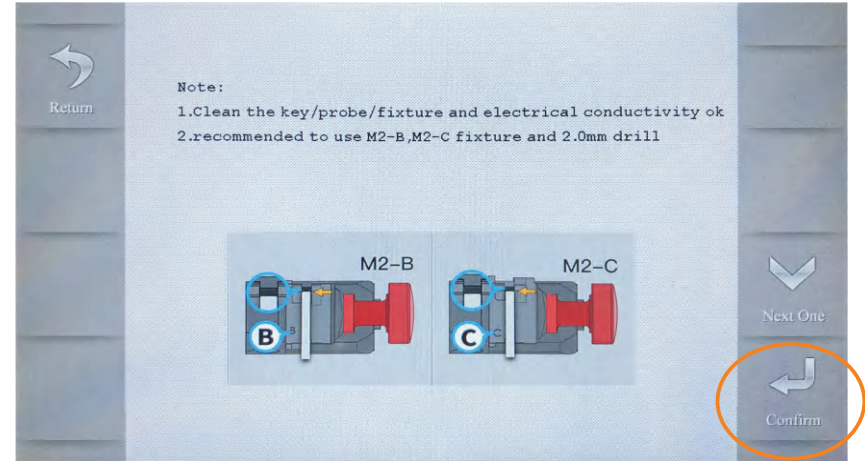

5) According to above information put the key into proper position, keep the key /probe/ clamp clean and with good electrical conductivity, click on 'Confirm'.

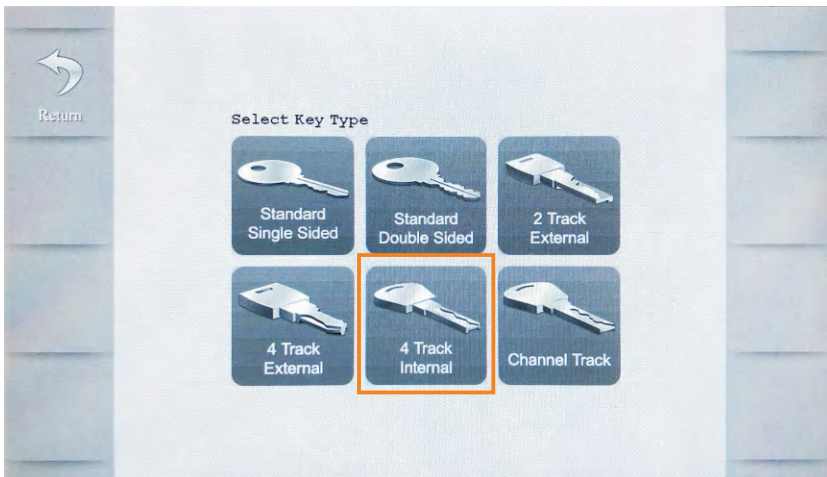

4) For example, '4 Track Internal' keys.

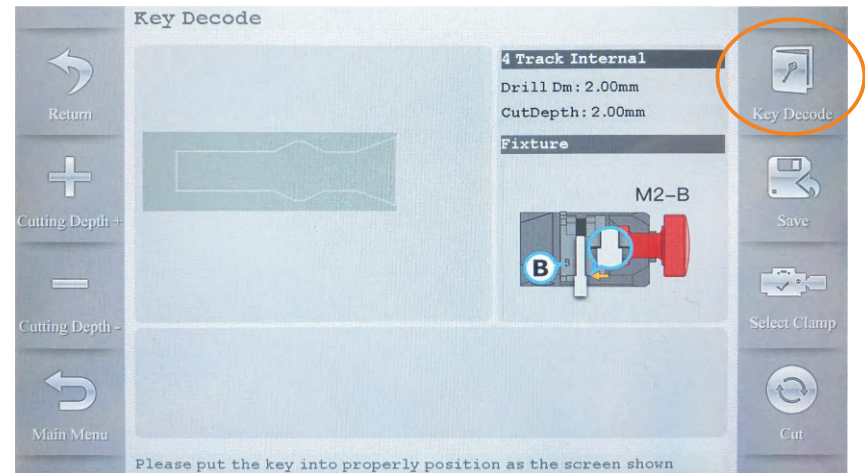

6) Select proper clamp, then click on 'Key Decode', probe will be detected many different points of whole key.

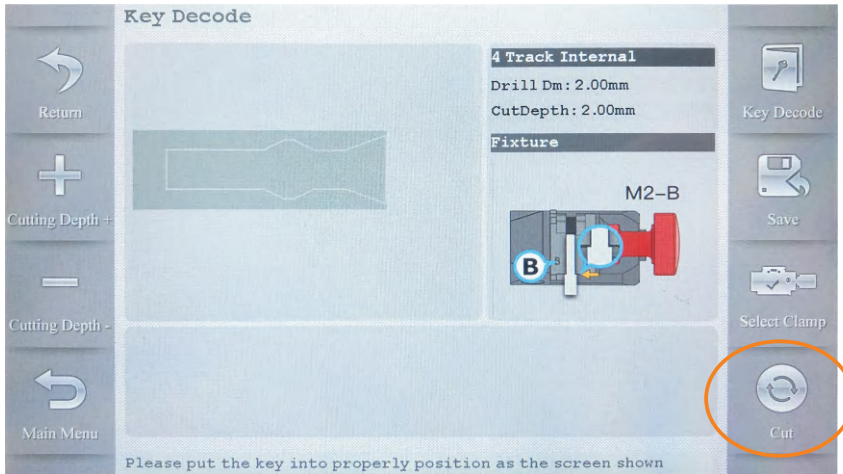

7) After decode key successful, click on 'Cut', wait until cutting complete.

Above sample just for '4 Track Internal Keys' decode and cut instructions, for other key types also same steps.

6.7 How to use cut by bitting

There are two ways of using cut by bitting function, with original key or without original key.

Method 1 for making keys without the original key.

Two ways to getting the key bitting: Use some special tool to get the key bitting or remove the lock to read the key bitting on each wafer.



1) Click 'Cut by Bitting'.

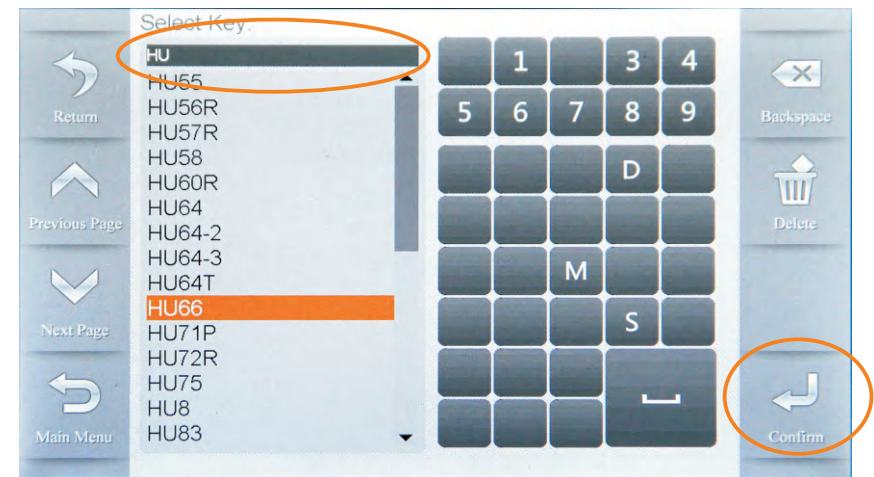

2) Select the key blank type and click on 'Confirm'.

Method 2 for making a key with the original key

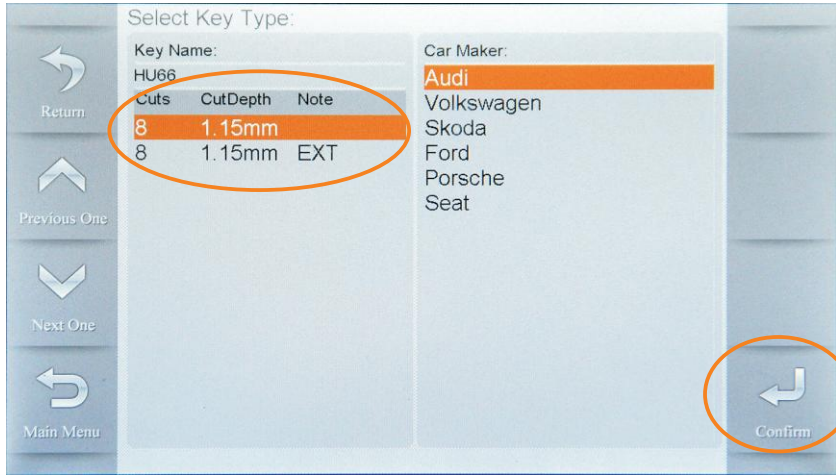

3) Select the key type and click on 'Confirm'.

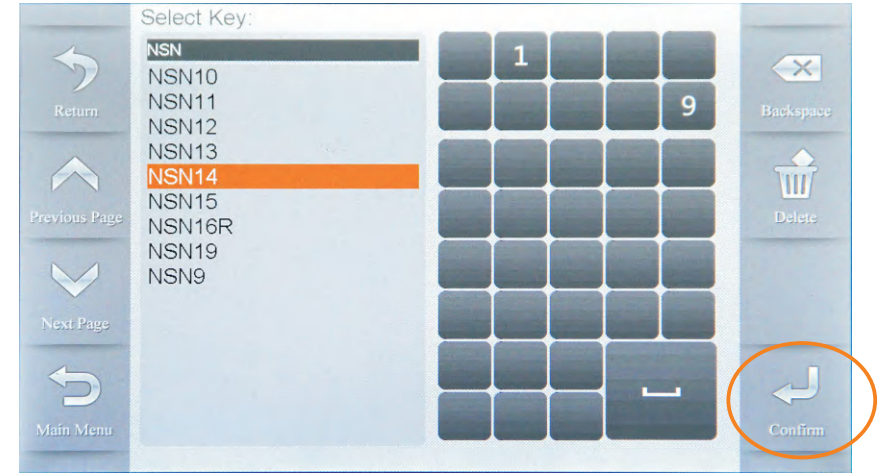

1) Click 'Cut by Bitting', then click on 'Confirm'.



4) Fix the key according to the picture show, select correct side of clamp and fix the key in correct position .
Enter key bitting and check all the information before you click on 'Cut' for cutting keys.

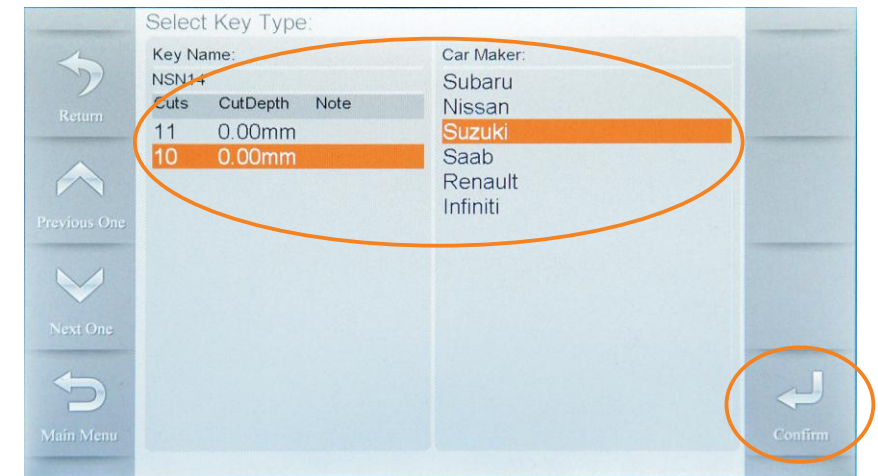

2) Select the key type and click on 'Confirm'.

6.8 How to use find bitting

Parts of the cars are missing bitting on door lock/trunk lock if compare with ignition lock. Users can find out the unknown bitting and replace the unknown bitting as"?"

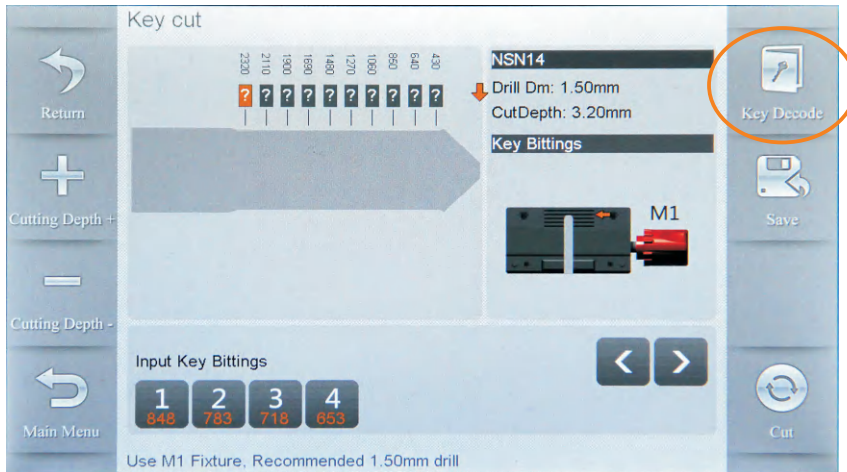

3) Click on 'Key Decode' to get the key bittings.



1) Click on 'Find Bitting'.

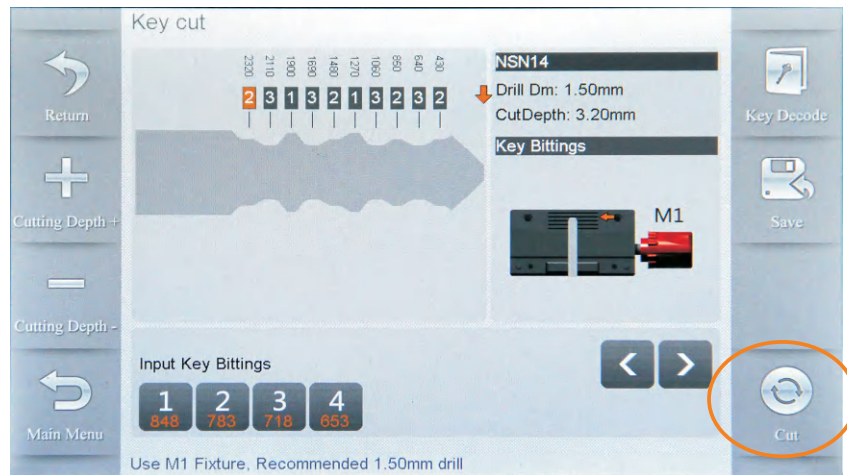

4) Put the new blank key to the correct position and click on 'Cut' for cutting keys.

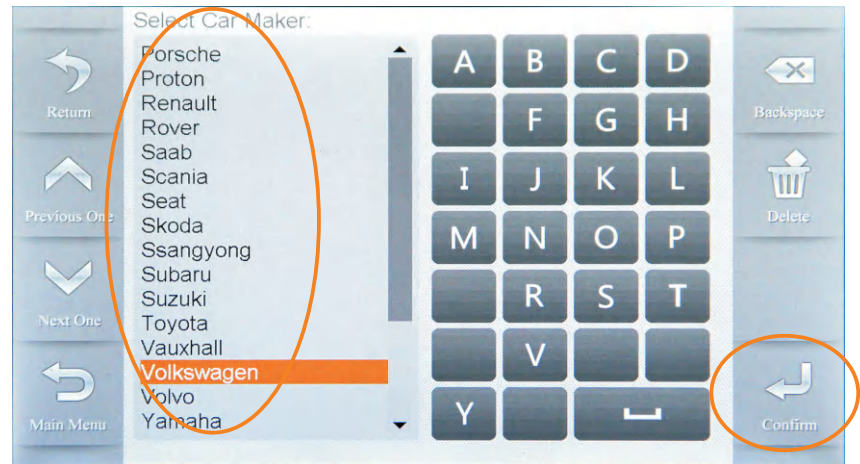

2) Select a car maker or put in the initial letter of the car maker, then click on 'Confirm'.

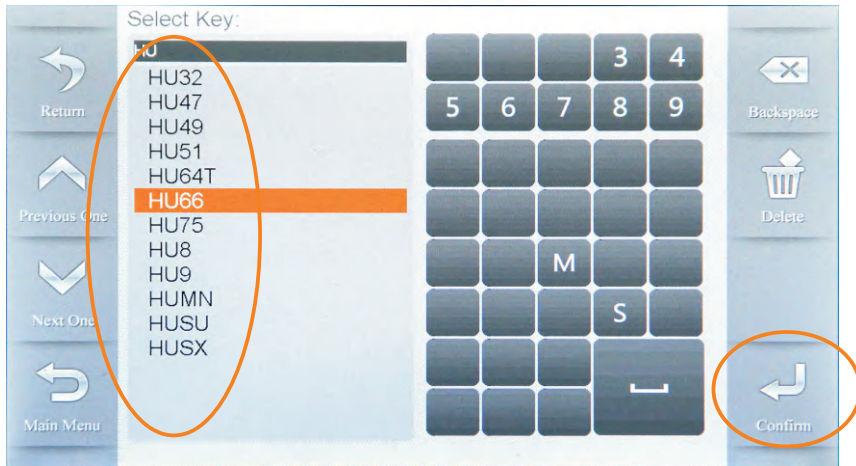

3) Select or enter key type and click on 'Confirm'.

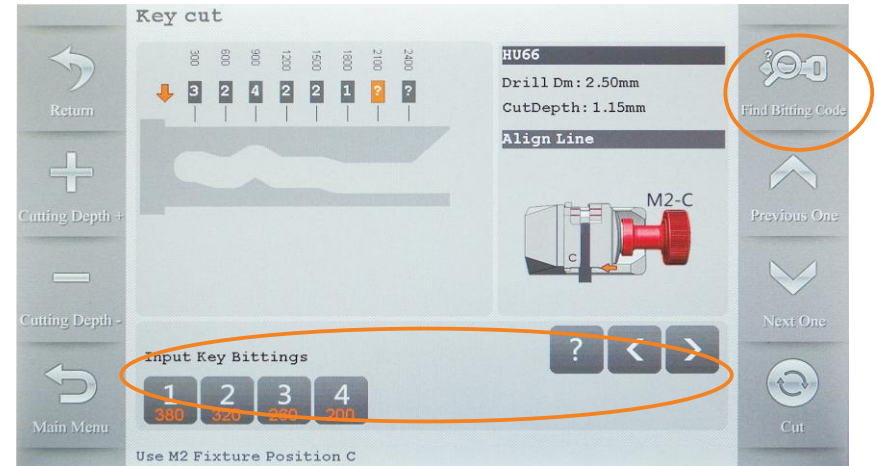

5) Enter the known bittings, if the bitting is unknown, enter '?' as replace, then click on 'Find Bitting Code'.

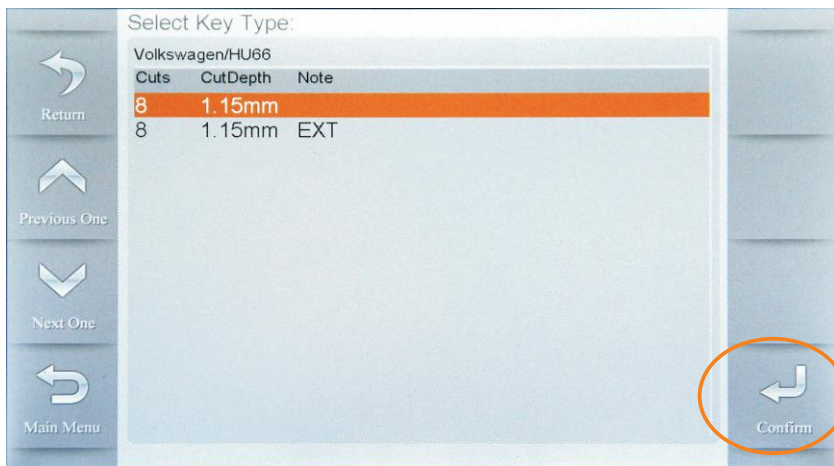

4) Select key type and click on 'Confirm'.

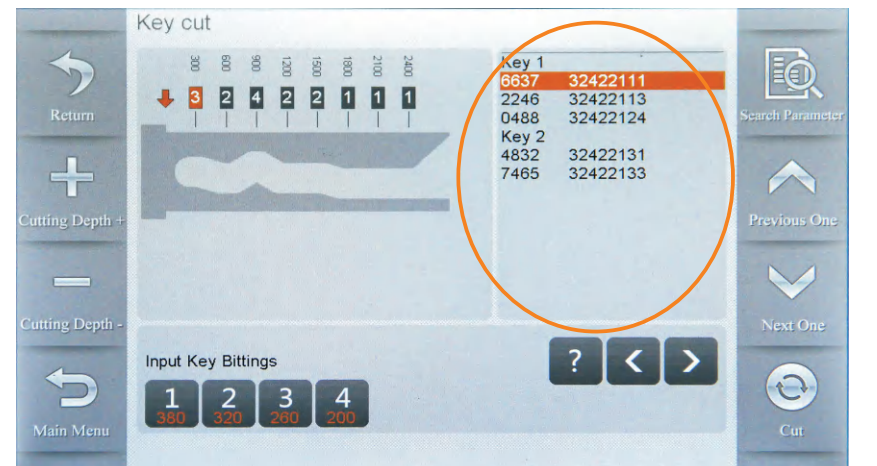

6) Machine will show all possible results, just try one by one to cut keys until it works.

7. Online update

There are 3 ways to get 'Upgrade kit' file for firmware update

1. Contact your distributor ask for the software.
2. Contact Xhorse technical support skype: Live: condor_keymachine@hotmail.com
3. Scan the QR code to download and install Xhorse APP.



update tool.rar



Scan QR Code to download Xhorse APP

- 1) Unzip the Upgrade kit file after the file has been downloaded.

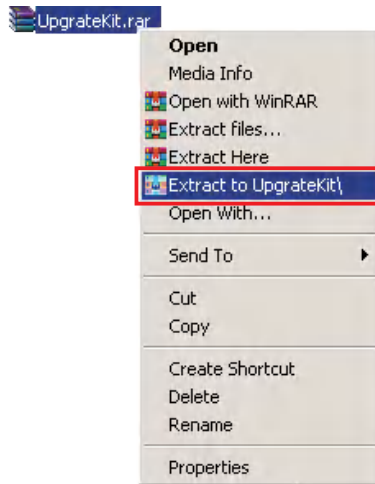

- 2) Run 'Upgrade Kit.exe' and connect the machine with the pc, do not turn off the machine during update process and also the upgrade kit software will update automatically.



- 3) Open the file of 'Driver' from those decompressed files and choose a relatively new driver to install. If the computer still can not recognize the machine after the installation of the driver, it is advisable to change to another driver. If all the drivers fail, please contact your distributor or technical support from the manufacturer.



- 4) After the machine is successfully communicated with the computer, read the serial number, then select the XC-MINI PLUS and click to update.

Note : Please keep the machine connected to the computer by USB during the update.

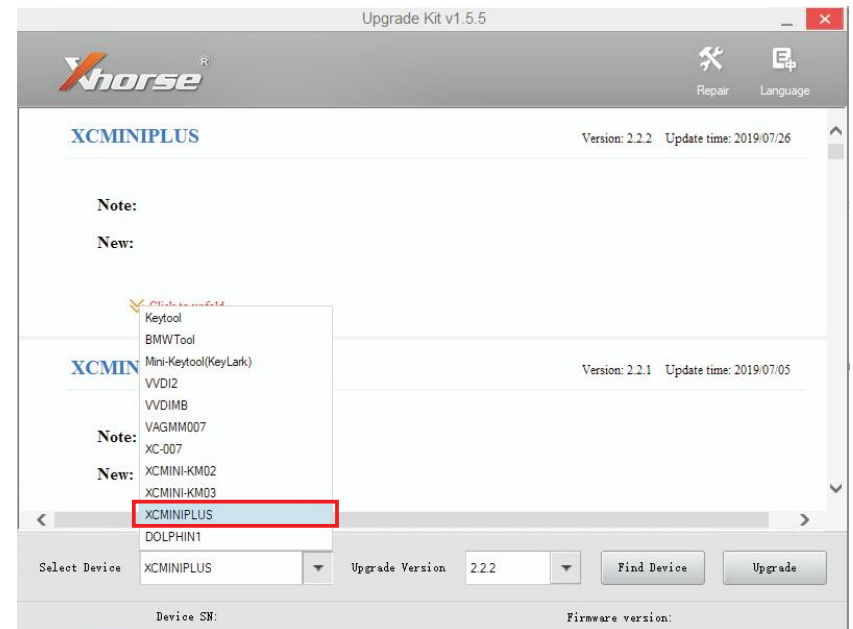

8. Maintenance

- Please clean the area around clamps with a brush before the machine starts to work. This is to assure cutting precision and avoid components damage by metal particles.
- To avoid damage or corrosion to the machine, please do not use detergent or other cleaning products to clean the machine.
- Please do not flush or wet the machine with water, in case rust and electrical current leakage.
- Under any circumstance, please do not try to clean the working area with air guns and drying machines, in case any metal carvings getting inside the machine.

9. After-sale description

Regarding to customer service and technical support, please contact distributors or Xhorse online customer service team by scanning the QR code below and downloading Xhorse official App.



Scan QR Code to download Xhorse APP

All the information and illustrations in this document are for guidance only. Xhorse reserves the right to alter products designs, dimensions or info to improve the products quality. The contents of this document are fully protected by Copyright and may not be copied or reproduced in any form (e.g. mechanical, electronic, printing or video recording), without permission from Xhorse.

